

# ANKER FLEXCO

TRANSPORTBAND-VERBINDUNGSSYSTEME  
CONVEYOR BELT FASTENING SYSTEMS  
SYSTÈMES D'AGRAFAGE POUR BANDES TRANSPORTEUSES



**Programmübersicht**  
Alligator/Flexco/Tatch A Cleat



**Program Overview**  
Alligator/Flexco/Tatch A Cleat



**Gamme de produits**  
Alligator/Flexco/Tatch A Cleat

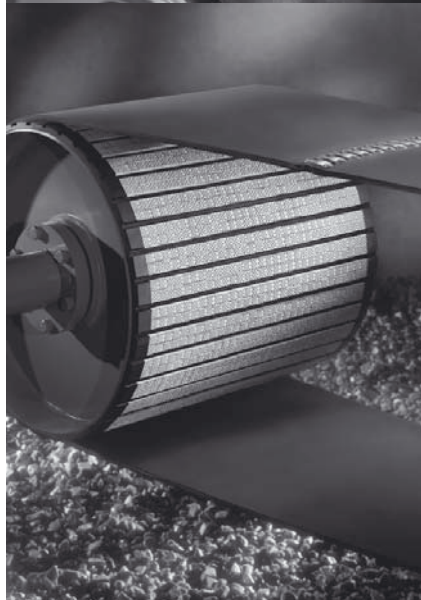



### **ALLIGATOR Lacing**

Transportband - Verbindungssystem für Bandstärken bis 11 mm  
 Conveyor Belt Fastening System for Belts up to 11 mm thick  
 Système d'agrafage pour bandes transporteuses jusqu'à d'épaisseur 11 mm ..... 4

### **ALLIGATOR Ready Set**

Transportband - Verbindungssystem für Bandstärken von 1,5 bis 6,4 mm  
 Conveyor Belt Fastening System for Belts 1,5 to 6,4 mm thick  
 Système d'agrafage pour bandes transporteuses d'épaisseur 1,5 - 6,4 mm ..... 6

### **ALLIGATOR Plastic Rivet**

Plastikverbinder für Bandstärken von 1,6 - 3,2 mm  
 Plastic Rivet Fasteners for Belts 1,6 - 3,2 mm thick  
 Agrafes plastiques pour bandes transporteuses d'épaisseur 1,6 - 3,2 mm ..... 9

### **ALLIGATOR Rivet**

Transportband - Verbindungssystem für Rundballenpressen  
 Conveyor Belt Fastening System for Round Balers  
 Système d'agrafage pour bandes transporteuses pour presses à balles ..... 10

### **FLEXCO Rivet Solid Plate**

Transportband - Verbindungssystem für Bandstärken von 6 bis 24 mm  
 Conveyor Belt Fastening System for Belts 6 to 24 mm thick  
 Système d'agrafage pour bandes transporteuses d'épaisseur 6 - 24 mm ..... 11

### **FLEXCO Rivet Hinged**

Transportband - Verbindungssystem für Bandstärken von 5 bis 17 mm  
 Conveyor Belt Fastening System for Belts 5 to 17 mm thick  
 Système d'agrafage pour bandes transporteuses d'épaisseur 5 - 17 mm ..... 12

### **FLEXCO Bolt Hinged**

Transportband - Verbindungssystem für Bandstärken von 6 bis 16 mm  
 Conveyor Belt Fastening System for Belts 6 to 16 mm thick  
 Système d'agrafage pour bandes transporteuses d'épaisseur 6 - 16 mm ..... 18

### **FLEXCO Bolt Solid Plate**

Transportband - Verbindungssystem für Bandstärken von 5 bis 30 mm  
 Conveyor Belt Fastening System for Belts 5 to 30 mm thick  
 Système d'agrafage pour bandes transporteuses d'épaisseur 5 - 30 mm ..... 20

### **FLEXCO Bolt Hinged / Bolt Solid Plate**

Extra Schrauben und Muttern  
 Extra Bolts and Nuts  
 Vis et écrous supplémentaires. .... 23

### **ALLIGATOR/FLEXCO**

Bandschneider und Zubehör  
 Belt Cutters and Accessories  
 Coupeuses de bande et accessoires. .... 24

### **Rockline / Mineline / Eliminator**

Bandabstreifer  
 Belt Cleaners  
 Racleurs de bande. .... 27

### **TATCH A CLEAT**

Schraubstollen und Führungsprofile  
 Mechanical Belt Cleats and Guides  
 Profils à vis et de guidage ..... 30

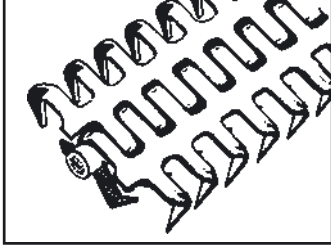

## ALLIGATOR Lacing

Transportband -  
Verbindungssystem für  
Bandstärken bis 11 mm

Conveyor Belt Fastening  
System for Belts up to  
11 mm thick

Système d'agrafage pour  
bandes transporteuses  
jusqu'à d'épaisseur 11 mm

| Verbindergroße<br>Fastener Size<br>Taille des agrafes | empf. Bandstärkenbereich<br>Belt Thickness Range<br>Épaisseur de bandes<br>recommandée mm | empf. kleinster Trommel-Ø<br>rec. min. Pulley-Ø<br>Ø tambour mini.rec.<br>mm |
|---|---|--|
| <b>00</b>   | - 1,6   | 25   |
| <b>1</b>  | 1,6 - 2,4   | 40   |
| <b>7</b>  | 2,4 - 3,6   | 50   |
| <b>15</b>   | 3,2 - 4,0   | 65   |
| <b>20</b>   | 4,0 - 4,8   | 75   |

| Verbindergroße<br>Fastener Size<br>Taille des agrafes | empf. Bandstärkenbereich<br>Belt Thickness Range<br>Épaisseur de bandes<br>recommandée mm | empf. kleinster Trommel-Ø<br>rec. min. Pulley-Ø<br>Ø tambour mini.rec.<br>mm |
|---|---|--|
| <b>25</b>   | 4,8 - 5,6   | 100  |
| <b>27</b>   | 5,6 - 7,1   | 125  |
| <b>35</b>   | 7,1 - 7,9   | 175  |
| <b>45</b>   | 7,9 - 9,5   | 230  |
| <b>55</b>   | 9,5 - 11,0  | 300  |

**Inhalt:** Jeder Karton enthält 4  
komplette Verbindungen für  
die angegebene Bandbreite.

**Content:** Each Box contains 4  
Sets Lacing for the Belt Width  
specified.

**Contenu:** Chaque boîte contient 4  
jeux complets de jonction pour la  
largeur de bande spécifiée.

### Stahl / Steel / Acier

| Bestell-Nr.<br>Order-No.<br>No. de réf.                        | Bandbreite<br>Belt Width<br>Larg. de bande<br>mm | Gewicht<br>Weight<br>Poids<br>kg |
|--|--|----------------------------------|
| <b>00</b> (4 Verbindersets / Fastener Sets / Jeux de jonction) |  |                                  |
| <b>00-300</b>  | 300  | 0,14                             |
| <b>00-600</b>  | 600  | 0,28                             |
| <b>00-900</b>  | 900  | 0,42                             |
| <b>00-1200</b>   | 1200   | 0,57                             |
| <b>1A</b>  |  |                                  |
| <b>1A-300</b>  | 300  | 0,25                             |
| <b>1A-600</b>  | 600  | 0,49                             |
| <b>1A-900</b>  | 900  | 0,73                             |
| <b>1A-1000</b>   | 1000   | 0,82                             |
| <b>1A-1200</b>   | 1200   | 0,98                             |
| <b>1A-1500</b>   | 1500   | 1,22                             |
| <b>7</b>   |  |                                  |
| <b>7-300</b>   | 300  | 0,32                             |
| <b>7-600</b>   | 600  | 0,64                             |
| <b>7-900</b>   | 900  | 0,96                             |
| <b>7-1000</b>  | 1000   | 1,07                             |
| <b>7-1200</b>  | 1200   | 1,28                             |
| <b>7-1500</b>  | 1500   | 1,61                             |
| <b>15</b>  |  |                                  |
| <b>15-300</b>  | 300  | 0,46                             |
| <b>15-600</b>  | 600  | 0,91                             |
| <b>15-900</b>  | 900  | 1,37                             |
| <b>15-1200</b>   | 1200   | 1,83                             |
| <b>20</b>  |  |                                  |
| <b>20-300</b>  | 300  | 0,60                             |
| <b>20-600</b>  | 600  | 1,20                             |
| <b>20-900</b>  | 900  | 1,81                             |
| <b>20-1200</b>   | 1200   | 2,42                             |

### Stahl / Steel / Acier

| Bestell-Nr.<br>Order-No.<br>No. de réf.                        | Bandbreite<br>Belt Width<br>Larg. de bande<br>mm | Gewicht<br>Weight<br>Poids<br>kg |
|--|--|----------------------------------|
| <b>25</b> (4 Verbindersets / Fastener Sets / Jeux de jonction) |  |                                  |
| <b>25-300</b>  | 300  | 0,68                             |
| <b>25-600</b>  | 600  | 1,35                             |
| <b>25-900</b>  | 900  | 2,03                             |
| <b>25-1200</b>   | 1200   | 2,70                             |
| <b>27</b>  |  |                                  |
| <b>27-300</b>  | 300  | 0,80                             |
| <b>27-600</b>  | 600  | 1,60                             |
| <b>27-900</b>  | 900  | 2,38                             |
| <b>27-1200</b>   | 1200   | 3,18                             |
| <b>35</b>  |  |                                  |
| <b>35-300</b>  | 300  | 1,28                             |
| <b>35-600</b>  | 600  | 1,60                             |
| <b>35-900</b>  | 900  | 3,84                             |
| <b>35-1200</b>   | 1200   | 5,12                             |
| <b>45</b>  |  |                                  |
| <b>45-300</b>  | 300  | 1,51                             |
| <b>45-600</b>  | 600  | 3,17                             |
| <b>45-900</b>  | 900  | 4,75                             |
| <b>45-1200</b>   | 1200   | 6,34                             |
| <b>55</b>  |  |                                  |
| <b>55-300</b>  | 300  | 2,17                             |
| <b>55-600</b>  | 600  | 4,34                             |
| <b>55-900</b>  | 900  | 6,34                             |
| <b>55-1200</b>   | 1200   | 8,70                             |

## Rostfrei / Stainless / Inoxydable

| Bestell-Nr.<br>Order-No.<br>No. de réf. | Bandbreite<br>Belt Width<br>Larg. de bande<br>mm | Gewicht<br>Weight<br>Poids<br>kg |
|---|--|----------------------------------|
|---|--|----------------------------------|

### 00S (4 Verbindersets / Fastener Sets / Jeux de jonction)

|                 |      |      |
|-----------------|------|------|
| <b>00S-300</b>  | 300  | 0,14 |
| <b>00S-600</b>  | 600  | 0,28 |
| <b>00S-900</b>  | 900  | 0,42 |
| <b>00S-1200</b> | 1200 | 0,57 |

### 1S

|                |      |      |
|----------------|------|------|
| <b>1S-300</b>  | 300  | 0,25 |
| <b>1S-600</b>  | 600  | 0,49 |
| <b>1S-900</b>  | 900  | 0,73 |
| <b>1S-1000</b> | 1000 | 0,82 |
| <b>1S-1200</b> | 1200 | 0,98 |
| <b>1S-1500</b> | 1500 | 1,22 |

## Gelenkriemen- verbinder

## Transmission Belt Lacing

### Stahl / Steel / Acier

| Bestell-Nr.<br>Order-No.<br>No. de réf. | Verbinder Sets<br>Fastener Sets<br>Jeux de jonction | Gewicht<br>Weight<br>Poids<br>kg |
|---|---|----------------------------------|
|---|---|----------------------------------|

|            |         |      |
|------------|---------|------|
| <b>00</b>  | 6 X 150 | 0,09 |
| <b>1A</b>  | 6 X 150 | 0,15 |
| <b>7</b>   | 6 X 150 | 0,20 |
| <b>15</b>  | 8 X 300 | 0,41 |
| <b>20</b>  | 8 X 300 | 0,55 |
| <b>25D</b> | 8 X 300 | 0,64 |
| <b>27K</b> | 8 X 300 | 0,78 |
| <b>35N</b> | 8 X 300 | 1,23 |
| <b>45U</b> | 8 X 300 | 1,50 |
| <b>55W</b> | 8 X 300 | 2,14 |
| <b>65X</b> | 8 X 300 | 2,63 |

## Eco Pack

Jede VPE enthält 10 Verbindersets, einzeln verpackt.

Each package contains 10 sets of lacing, individually packed.

Chaque unité d'emballage comprend 10 jeux de jonction, emballés individuellement.

| Bestell-Nr.<br>Order-No.<br>No. de réf. | Verbinder Sets<br>Fastener Sets<br>Jeux de jonction | Gewicht<br>Weight<br>Poids<br>kg |
|---|---|----------------------------------|
|---|---|----------------------------------|

|            |          |      |
|------------|----------|------|
| <b>15E</b> | 10 X 300 | 0,41 |
| <b>20E</b> | 10 X 300 | 0,55 |
| <b>25E</b> | 10 X 300 | 0,64 |
| <b>27E</b> | 10 X 300 | 0,78 |
| <b>35E</b> | 10 X 300 | 1,23 |

## Rostfrei / Stainless / Inoxydable

| Bestell-Nr.<br>Order-No.<br>No. de réf. | Bandbreite<br>Belt Width<br>Larg. de bande<br>mm | Gewicht<br>Weight<br>Poids<br>kg |
|---|--|----------------------------------|
|---|--|----------------------------------|

### 7S

|                |      |      |
|----------------|------|------|
| <b>7S-300</b>  | 300  | 0,32 |
| <b>7S-600</b>  | 600  | 0,64 |
| <b>7S-900</b>  | 900  | 0,96 |
| <b>7S-1000</b> | 1000 | 1,07 |
| <b>7S-1200</b> | 1200 | 1,28 |
| <b>7S-1500</b> | 1500 | 1,61 |

## Agrafes flexibles pour courroies de transmission

### Rostfrei / Stainless / Inoxydable

| Bestell-Nr.<br>Order-No.<br>No. de réf. | Verbinder Sets<br>Fastener Sets<br>Jeux de jonction | Gewicht<br>Weight<br>Poids<br>kg |
|---|---|----------------------------------|
|---|---|----------------------------------|

|             |         |      |
|-------------|---------|------|
| <b>00S</b>  | 6 X 150 | 0,09 |
| <b>1AS</b>  | 6 X 150 | 0,15 |
| <b>7S</b>   | 6 X 150 | 0,20 |
| <b>15S</b>  | 8 X 300 | 0,41 |
| <b>20S</b>  | 8 X 300 | 0,55 |
| <b>25DS</b> | 8 X 300 | 0,64 |
| <b>27KS</b> | 8 X 300 | 0,78 |
| <b>35NS</b> | 8 X 300 | 1,23 |
| <b>45US</b> | 8 X 300 | 1,50 |
| <b>55WS</b> | 8 X 300 | 2,14 |



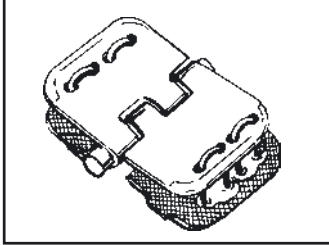

## ALLIGATOR Ready Set

Transportband-  
Verbindungssystem für  
Bandstärken von  
1,5 - 6,4 mm

Conveyor Belt Fastening  
System for Belts 1,5 - 6,4  
mm thick

Système d'agrafage pour  
bandes transporteuses  
d'épaisseur 1,5 - 6,4 mm

| Verbindergroße<br>Fastener Size<br>Taille des agrafes | Für Transportbänder bis zu... N/mm Festigkeit<br>For Belts with a Tensile Strength of up to... N/mm<br>Pour bandes tranporteuses à résistance<br>de rupture jusqu'à... N/mm | empf. Bandstärkenbereich<br>Belt Thickness Range<br>Épaisseur de bandes recommandée<br>mm | empf. kleinster Trommel-Ø<br>rec. min. Pulley-Ø<br>Ø tambour mini.rec.<br>mm |
|---|---|---|--|
| <b>RS62</b>   | 200   | 1,5 - 3,2   | 50   |
| <b>RS125</b>  | 315   | 3,2 - 4,8   | 75   |
| <b>RS187</b>  | 400   | 4,8 - 6,4   | 100  |

**Inhalt:** Jeder J-Karton enthält 4  
komplette Verbindungen für  
die angegebene Bandbreite.

**Content:** Each J-box contains 4  
Sets Lacing for the Belt Width  
specified.

**Contenu:** Chaque boîte J contient  
4 jeux complets de jonction  
pour la largeur de bande spécifiée.

### Stahl verzinkt Galvanized Steel / Acier galvanisé

| Bestell-Nr.<br>Order-No.<br>No. de réf. | Bandbreite<br>Belt Width<br>Larg. de bande<br>mm | Gewicht<br>Weight<br>Poids<br>kg |
|---|--|----------------------------------|
| <b>RS62J12/300NC</b>                    | 300  | 0,61                             |
| <b>RS62J24/600NC</b>                    | 600  | 1,22                             |
| <b>RS62J32/800NC</b>                    | 800  | 1,64                             |
| <b>RS62J40/1000NC</b>                   | 1000   | 2,05                             |
| <b>RS62J47/1200NC</b>                   | 1200   | 2,44                             |
| <b>RS62J59/1500NC</b>                   | 1500   | 3,05                             |
| <b>RS125J12/300NC</b>                   | 300  | 0,91                             |
| <b>RS125J24/600NC</b>                   | 600  | 1,78                             |
| <b>RS125J32/800NC</b>                   | 800  | 2,43                             |
| <b>RS125J40/1000NC</b>                  | 1000   | 3,04                             |
| <b>RS125J47/1200NC</b>                  | 1200   | 3,65                             |
| <b>RS125J59/1500NC</b>                  | 1500   | 4,56                             |
| <b>RS187J12/300NC</b>                   | 300  | 1,16                             |
| <b>RS187J24/600NC</b>                   | 600  | 2,69                             |
| <b>RS187J32/800NC</b>                   | 800  | 3,36                             |
| <b>RS187J40/1000NC</b>                  | 1000   | 4,20                             |
| <b>RS187J47/1200NC</b>                  | 1200   | 5,33                             |
| <b>RS187J59/1500NC</b>                  | 1500   | 6,26                             |

### Rostfrei Stainless / Inoxydable

| Bestell-Nr.<br>Order-No.<br>No. de réf. | Bandbreite<br>Belt Width<br>Larg. de bande<br>mm | Gewicht<br>Weight<br>Poids<br>kg |
|---|--|----------------------------------|
| <b>RS62SJ12/300NCS</b>                  | 300  | 0,61                             |
| <b>RS62SJ24/600NCS</b>                  | 600  | 1,22                             |
| <b>RS62SJ32/800NCS</b>                  | 800  | 1,64                             |
| <b>RS62SJ40/1000NCS</b>                 | 1000   | 2,05                             |
| <b>RS62SJ47/1200NCS</b>                 | 1200   | 2,44                             |
| <b>RS62SJ59/1500NCS</b>                 | 1500   | 3,05                             |
| <b>RS125SJ12/300NCS</b>                 | 300  | 0,91                             |
| <b>RS125SJ24/600NCS</b>                 | 600  | 1,78                             |
| <b>RS125SJ32/800NCS</b>                 | 800  | 2,43                             |
| <b>RS125SJ40/1000NCS</b>                | 1000   | 3,04                             |
| <b>RS125SJ47/1200NCS</b>                | 1200   | 3,65                             |
| <b>RS125SJ59/1500NCS</b>                | 1500   | 4,56                             |
| <b>RS187SJ12/300NCS</b>                 | 300  | 1,16                             |
| <b>RS187SJ24/600NCS</b>                 | 600  | 2,69                             |
| <b>RS187SJ32/800NCS</b>                 | 800  | 3,36                             |
| <b>RS187SJ40/1000NCS</b>                | 1000   | 4,20                             |
| <b>RS187SJ47/1200NCS</b>                | 1200   | 5,33                             |
| <b>RS187SJ59/1500NCS</b>                | 1500   | 6,26                             |

25 Verbindersets (ohne Kupplungsstäbe) · 25 Fastener Sets (without Hinge Pins) · 25 Jeux de jonction (sans axe)

|                         |      |       |                          |      |       |
|-------------------------|------|-------|--------------------------|------|-------|
| <b>RS62-47/1200-25</b>  | 1200 | 13,50 | <b>RS62S-47/1200-25</b>  | 1200 | 13,50 |
| <b>RS125-47/1200-25</b> | 1200 | 18,70 | <b>RS125S-47/1200-25</b> | 1200 | 18,70 |
| <b>RS187-47/1200-25</b> | 1200 | 27,50 | <b>RS187S-47/1200-25</b> | 1200 | 27,50 |

### MegAlloy

| Bestell-Nr.<br>Order-No.<br>No. de réf. | Inhalt<br>Content<br>Contenu | Gewicht<br>Weight<br>Poids<br>kg |
|---|------------------------------|----------------------------------|
| <b>125MA</b>                            | 8 X 300 mm                   | 1,9                              |
| <b>187MA</b>                            | 8 X 300 mm                   | 2,6                              |

### Extra Klammern, rostfrei · Extra Staples, stainless Crampons supplémentaires, inoxydables

| Bestell-Nr.<br>Order-No.<br>No. de réf. | Verbindergroße<br>Fastener size<br>Taille d'agrafe | Inhalt<br>Content<br>Contenu | Gewicht<br>Weight<br>Poids<br>kg |
|---|--|------------------------------|----------------------------------|
| <b>S125</b>                             | 125  | 990                          | 0,41                             |
| <b>S187</b>                             | 187  | 990                          | 0,46                             |

| <b>Kupplungsdrähte</b><br><b>Hinge Material</b><br><b>Axes de jonction</b>     | Bestell-Nr.<br>Order-No.<br>No. de réf.  | Ø<br>mm           | Verbindergröße<br>Fastener Size<br>Taille d'agrafe | Inhalt<br>Content<br>Contenu | Gewicht<br>Weight<br>Poids<br>kg |      |
|--|--|-------------------|--|------------------------------|----------------------------------|------|
| <b>NC</b>  | <b>NC62-X</b>  | 2,0               | RS62   | 3 m                          | 0,05                             |      |
|  | <b>NC62-C</b>  |                   |  | 30 m                         | 0,45                             |      |
|  | <b>NC1-X</b>   | 3,6               | RS125  | 3 m                          | 0,09                             |      |
|  | <b>NC1-C</b>   |                   |  | 30 m                         | 0,77                             |      |
|  | <b>NC187-X</b>   | 5,2               | RS187  | 3 m                          | 0,09                             |      |
|  | <b>NC187-C</b>   |                   |  | 30 m                         | 2,17                             |      |
| <b>NCS</b>   | <b>NCS62-X</b>   | 2,0               | RS62   | 3 m                          | 0,05                             |      |
|  | <b>NCS62-C</b>   |                   |  | 30 m                         | 0,45                             |      |
|  | <b>NCS1-X</b>  | 3,6               | RS125  | 3 m                          | 0,09                             |      |
|  | <b>NCS1-C</b>  |                   |  | 30 m                         | 0,77                             |      |
|  | <b>NCS187-X</b>  | 5,2               | RS187  | 3 m                          | 0,09                             |      |
|  | <b>NCS187-C</b>  |                   |  | 30 m                         | 2,17                             |      |
| <b>SP</b><br>* Bandbreite (mm)<br>* Belt Width (mm)<br>* Largeur de bande (mm) | <b>SP62-1000</b>   | 2,0               | RS62   | 10 X 1000* mm                | 0,32                             |      |
|  | <b>SP62-1200</b>   |                   |  | 10 X 1200* mm                | 0,37                             |      |
|  | <b>SP62-1500</b>   |                   |  | 10 X 1500* mm                | 0,40                             |      |
|  | <b>SP1-1000</b>  | 3,6               | RS125  | 10 X 1000* mm                | 0,68                             |      |
|  | <b>SP1-1200</b>  |                   |  | 10 X 1200* mm                | 0,87                             |      |
|  | <b>SP1-1500</b>  |                   |  | 10 X 1500* mm                | 1,00                             |      |
|  | <b>SP2-1000</b>  | 4,7               | RS187  | 10 X 1000* mm                | 1,23                             |      |
|  | <b>SP2-1200</b>  |                   |  | 10 X 1200* mm                | 1,55                             |      |
|  | <b>SP2-1500</b>  |                   |  | 10 X 1500* mm                | 1,80                             |      |
|  | <b>SS</b><br>* Bandbreite (mm)<br>* Belt Width (mm)<br>* Largeur de bande (mm) | <b>SS62-1000</b>  | 2,0  | RS62                         | 10 X 1000* mm                    | 0,32 |
|  |  | <b>SS62-1200</b>  |  |                              | 10 X 1200* mm                    | 0,37 |
|  |  | <b>SS62-1500</b>  |  |                              | 10 X 1500* mm                    | 0,42 |
| <b>SS1-1000</b>  |  | 3,6               | RS125  | 10 X 1000* mm                | 0,68                             |      |
| <b>SS1-1200</b>  |  |                   |  | 10 X 1200* mm                | 0,87                             |      |
| <b>SS1-1500</b>  |  |                   |  | 10 X 1500* mm                | 1,00                             |      |
| <b>SS2-1000</b>  |  | 4,7               | RS187  | 10 X 1000* mm                | 1,23                             |      |
| <b>SS2-1200</b>  |  |                   |  | 10 X 1200* mm                | 1,55                             |      |
| <b>SS2-1500</b>  |  |                   |  | 10 X 1500* mm                | 1,95                             |      |
| Kupplungsstab-Sicherungs-<br>scheiben  |  | <b>62-RET-50</b>  |  | RS62                         | 50                               | 0,04 |
|  |  | <b>125-RET-50</b> |  | RS125                        | 50                               | 0,05 |
| Hinge Pin Retaining Washers  |  | <b>187-RET-50</b> |  | RS187                        | 50                               | 0,06 |
| Rondelles de butée pour<br>axes de jonction                                    | <b>310-RET-50</b>  |                   | 375X/550/R2/R5                                     | 50                           | 0,15                             |      |
| Kupplungsstab-Bieger<br>Pin Bender<br>Outil à plier l'axe<br>de jonction       | <b>PB1</b>   |                   |  |                              | 0,5                              |      |

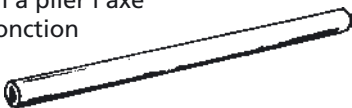

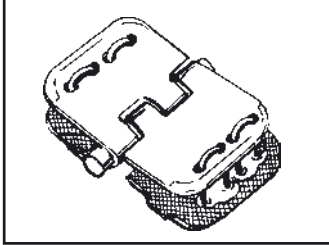

## ALLIGATOR Ready Set

Montagewerkzeuge und  
Zubehör

Installation Tools and  
Accessories

Outillage de montage et  
accessoires

### RSTK-Werkzeugkoffer

mit RSC187-Gerät, Klammersetzplatte,  
Hammer, Rillenhebel, Bandedcken-  
trimmzange.

### RSTK-Staple Kit

with RSC187 Installation Tool, Staple  
Set Plate, Hammer, Hand Skiver,  
Belt Nippers.

### RSTK-Coffret d'outillage

avec appareil de montage RSC187,  
plaque de pose de crampons, marteau,  
rabot pour courroie, pince à rogner.

Bestell-Nr.  
Order-No.  
No. de réf.

Gerät  
Tool  
Outil

Gewicht  
Weight  
Poids  
kg

**RSTK4-6**  
**RSTK4-12**

RSC187-6  
RSC187-12

8,8  
12,1

Bestell-Nr.  
Order-No.  
No. de réf.

Breite  
Width  
Largeur  
mm

Gewicht  
Weight  
Poids  
kg

### Montagegeräte Staple Driving Tools Appareils de montage

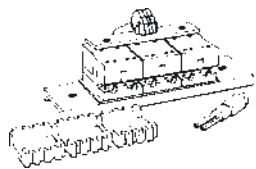

**RSC187**  
**RSC187-4**  
**RSC187-6**  
**RSC187-12**  
**RSC187-18**  
**RSC187-24**  
**RSC187-36**  
**RSC187-48**  
**RSC187-60**

50  
100  
150  
300  
450  
600  
900  
1200  
1500

0,5  
1,5  
3,0  
5,0  
7,5  
9,0  
14,0  
17,0  
25,0

### GOLD CLASS Montagegerät GOLD CLASS Installation Tool GOLD CLASS Appareil de montage



**RS-GOLD-DRIVER**  
**RS-GOLD-INITIAL-12/300**  
**RS-GOLD-INITIAL-24/600**  
**RS-GOLD-INITIAL-36/900**  
**RS-GOLD-INITIAL-48/1200**  
**RS-GOLD-FINAL-12/300**  
**RS-GOLD-FINAL-24/600**  
**RS-GOLD-FINAL-36/900**  
**RS-GOLD-FINAL-48/1200**

5,6  
4,8  
9,0  
11,5  
13,6  
4,9  
9,9  
12,3  
14,5

### Pressbacken für hydraulische Maschinen

### Press Plates for Hydraulic Lacers

### Mâchoires pour agrafeuses hydrauliques

Für / for / pour

**P2AS**  
**P6AS**

ARU 2000/3000  
AMK 400 / AMU 4000/6000

3,0  
5,0

### Ersatzteile Spare Parts Pièces de rechange

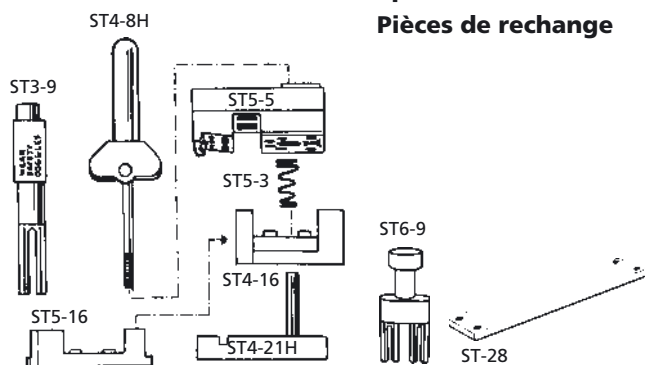

**ST5-3** Druckfeder / Spring / Ressort de pression  
**ST3-9** Klammertreiber / Staple Driver / Chasoir de crampons  
**ST6-9** Klammertreiber / Staple Driver / Chasoir de crampons  
**ST4-8H** Nockenhebel komplett / Cam Lever Assembly / Levier de tension complet (> RSC187-6)  
**ST4-16** Kamm grün / Comb green / Peigne vert (125/187)  
**ST5-16** Kamm gelb / Comb yellow / Peigne jaune (62/125)  
**ST5-5** Führungsblock / Guide Block / Bloc de guidage  
**ST-28** Klammersetzplatte / Staple Set Plate / Plaque de pose de crampons  
**ST3-13** Schraube / Bolt / Vis  
**ST3-14** Fixierstift / Cam Locating Pin / Goupille  
**ST3-15-6** Klemmschiene / Clamp Bar / Rail de serrage  
**ST4-21H** Amboßsegment / Anvil / Segment d'enclume  
**ST7-5** Block schwarz / Guide Block black / Bloc de guidage noir  
**ST7-9** Stößel / Punch / Poinçon  
**ST7-29** Setzplatte / Wear Plate / Plaque de pose



# ALLIGATOR Plastic Rivet

Plastikverbinder  
für Bandstärken  
von 1,6 - 3,2 mm

Plastic Rivet Fasteners  
for Belts  
1,6 - 3,2 mm thick

Agrafes plastiques pour  
bandes transporteuses  
d'épaisseur 1,6 - 3,2 mm

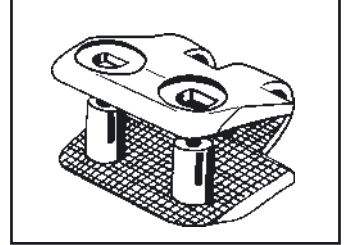

| Verbindergröße<br>Fastener Size<br>Taille des agrafes | Für Transportbänder bis zu... N/mm Festigkeit<br>For Belts with a Tensile Strength of up to... N/mm<br>Pour bandes tranporteuses à résistance<br>de rupture jusqu'à... N/mm | empf. Bandstärkenbereich<br>Belt Thickness Range<br>Épaisseur de bandes recommandée<br>mm | empf. kleinster Trommel-Ø<br>rec. min. Pulley-Ø<br>Ø tambour mini.rec.<br>mm |
|---|---|---|--|
| <b>APF100</b>   | 75  | -2,4  | 40   |
| <b>APF150</b>   | 100   | 1,6 - 3,2   | 75   |

## Plastikverbinder · Non metallic Fasteners · Agrafes plastiques

| Bestell-Nr.<br>Order-No.<br>No. de réf. | Inhalt<br>Content<br>Contenu | Gewicht<br>Weight<br>Poids<br>kg | Bestell-Nr.<br>Order-No.<br>No. de réf. | Inhalt<br>Content<br>Contenu | Gewicht<br>Weight<br>Poids<br>kg |
|---|------------------------------|----------------------------------|---|------------------------------|----------------------------------|
| <b>APF 100W-100*</b>                    | 100                          | 0,29                             | <b>APF 150W-100*</b>                    | 100                          | 0,45                             |
| <b>APF 100W-500**</b>                   | 500                          | 0,61                             | <b>APF 150W-500**</b>                   | 500                          | 0,97                             |
| <b>APF 100B-100*</b>                    | 100                          | 0,29                             | <b>APF 150B-100*</b>                    | 100                          | 0,45                             |
| <b>APF 100B-500**</b>                   | 500                          | 0,61                             | <b>APF 150B-500**</b>                   | 500                          | 0,97                             |

\* für Bandbreite 1200 mm mit Kupplungsdraht  
\* for belt width of 1200 mm with hinge material  
\* pour une épaisseur de bande de 1200 mm avec axe de jonction

\*\* ausreichend für 6 m Verbindung ohne Kupplungsdraht  
\*\* sufficient for 6 m splice without hinge material  
\*\* suffit pour 6 m de jonction sans axe de jonction

## Kupplungsdrähte · Hinge Material · Axes de jonction

| Bestell-Nr.<br>Order-No.<br>No. de réf. | Länge<br>Length<br>Longueur<br>m | Gewicht<br>Weight<br>Poids<br>kg | Bestell-Nr.<br>Order-No.<br>No. de réf. | Länge<br>Length<br>Longueur<br>m | Gewicht<br>Weight<br>Poids<br>kg |
|---|----------------------------------|----------------------------------|---|----------------------------------|----------------------------------|
| <b>NK2,50</b>                           | 30                               | 0,20                             | <b>NK3,50</b>                           | 30                               | 0,40                             |

## Montagegerät und Zubehör · Installation Tool and Accessories · Outillage de montage et accessoires

| Bestell-Nr.<br>Order-No.<br>No. de réf. | Gewicht<br>Weight<br>Poids<br>kg | Bestell-Nr.<br>Order-No.<br>No. de réf. | Gewicht<br>Weight<br>Poids<br>kg |
|---|----------------------------------|---|----------------------------------|
| <b>MDT220-1</b>                         | 15,90                            | <b>PRL4</b>                             | 0,17                             |
| <b>PCA7-600</b>                         | 4,08                             |   |                                  |

## Bohrschablonen · Templets · Gabarits

|                  |      |                  |      |
|------------------|------|------------------|------|
| <b>100T-600</b>  | 0,63 | <b>150T-600</b>  | 0,57 |
| <b>100T-1200</b> | 1,13 | <b>150T-1200</b> | 1,08 |

## Locheisen · Belt Punch · Poinçon

|              |      |              |      |
|--------------|------|--------------|------|
| <b>A100P</b> | 0,03 | <b>A150P</b> | 0,03 |
|--------------|------|--------------|------|

## Nietkopf · Curling Bit · Tête de pose

|              |      |              |      |
|--------------|------|--------------|------|
| <b>S100B</b> | 0,03 | <b>S150B</b> | 0,03 |
|--------------|------|--------------|------|

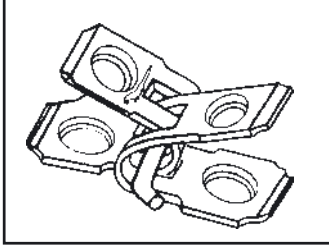

## ALLIGATOR Rivet

Transportband-  
Verbindungssystem für  
Rundballenpressen

Conveyor Belt Fastening  
System for Round Balers

Système d'agrafage pour  
bandes transporteuses  
pour presses à balles

| Verbindergröße<br>Fastener Size<br>Taille des agrafes | Für Transportbänder bis zu... N/mm Festigkeit<br>For Belts with a Tensile Strength of up to... N/mm<br>Pour bandes tranporteuses à résistance<br>de rupture jusqu'à... N/mm | empf. Bandstärkenbereich<br>Belt Thickness Range<br>Épaisseur de bandes recommandée<br>mm | empf. kleinster Trommel-Ø<br>rec. min. Pulley-Ø<br>Ø tambour mini.rec.<br>mm |
|---|---|---|--|
| <b>AR</b>   | 500   | 3,2 - 5,6   | 90   |

### Verbinder · Fasteners · Agrafes

| Bestell-Nr.<br>Order-No.<br>No. de réf. | Bandbreite<br>Belt Width<br>Larg. de bande<br>mm | Verbindungen<br>Fastener Sets<br>Jeux d'agrafes |
|---|--|---|
| <b>ARJ4/100</b>                         | 100  | 2   |
| <b>ARJ6/150</b>                         | 150  | 2   |
| <b>ARJ7/175</b>                         | 175  | 2   |
| <b>ARJ7/175-6STS</b>                    | 175  | 6   |
| <b>ARJ10/250</b>                        | 250  | 2   |
| <b>ARJ14/350</b>                        | 350  | 2   |



### Extra Kupplungsstäbe und Nieten Extra Hinge Pins and Rivets Axes et rivets supplémentaires

| Bestell-Nr.<br>Order-No.<br>No. de réf.  | Bandbreite<br>Belt Width<br>Larg. de bande<br>mm | Inhalt<br>Content<br>Contenu |
|--|--|------------------------------|
| gehärteter Stahl, gerillt/steel corrugated, heat-treated/acier rainuré, trempé |  |                              |
| <b>ARSH4/100</b>   | 100  | 9                            |
| <b>ARSH6/150</b>   | 150  | 8                            |
| <b>ARSH7/175</b>   | 175  | 8                            |
| <b>ARSH10/250</b>  | 250  | 4                            |
| <b>ARSH14/350</b>  | 350  | 4                            |
| <b>AR3-15</b>  | Nieten/Rivets                                    | 15                           |

### Geräte · Tools · Outils

| Bestell-Nr.<br>Order-No.<br>No. de réf. | Gerätebreite<br>Tool Width<br>Largeur d'outil<br>mm |
|---|---|
| <b>ART-7</b>                            | 175   |
| <b>ART-10</b>                           | 250   |
| <b>ART-14</b>                           | 350   |



### ARTK-Gerätekoffer

mit ART-Gerät, Rillenhobel, Hammer, Kupplungsstababbieger und 2 Kartons ARJ-Verbindersets in einem Plastikkoffer

### ARTK-Toolkit

includes ART Installation Tool, Hand Belt Skiver, Hammer, Pin Bender and 2 packages of ARJ fasteners in a plastic tool box

### Coffret ARTK

Contenu: outil de pose, rabot pour courroie, marteau, outil pour plier les axes et 2 cartons de jeux d'agrafes ARJ dans un coffret plastique

| Bestell-Nr.<br>Order-No.<br>No. de réf. | Gerätebreite<br>Tool Width<br>Largeur d'outil<br>mm |
|---|---|
| <b>ARTK-7</b>                           | 175   |
| <b>ARTK-14</b>                          | 350   |



# FLEXCO Rivet Solid Plate

Transportband -  
Verbindungssystem für  
Bandstärken  
von 6 bis 24 mm

Conveyor Belt Fastening  
System for Belts  
6 to 24 mm thick

Système d'agrafage pour  
bandes transporteuses  
d'épaisseur 6 - 24 mm

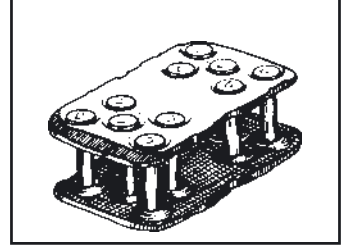

| Verbindergroße<br>Fastener Size<br>Taille des agrafes | Inhalt<br>Content<br>Contenu | Für Transportbänder bis zu... N/mm Festigkeit<br>For Belts with a Tensile Strength of up to... N/mm<br>Pour bandes transporteuses à résistance<br>de rupture jusqu'à... N/mm | empf. Bandstärkenbereich<br>Belt Thickness Range<br>Épaisseur de bandes recommandée<br>mm | empf. kleinster Trommel-Ø<br>rec. min. Pulley-Ø<br>Ø tambour mini.rec.<br>mm |
|---|------------------------------|--|---|--|
| <b>BR-10</b>  | 1,5 m                        | 1250   | 6 - 17  | 450  |
| <b>BR-14</b>  | 1,5 m                        | 1600   | 10 - 24   | 900  |

## Montagegeräte · Installation Tools Outillage de montage

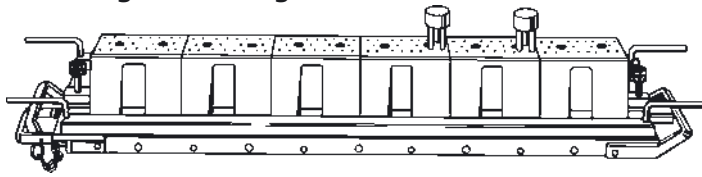

| Bestell-Nr.<br>Order-No.<br>No. de réf. | Breite<br>Width<br>Largeur<br>mm | Gewicht<br>Weight<br>Poids<br>kg |
|---|----------------------------------|----------------------------------|
| <b>MBRTA-42*</b>                        | 1050                             | 66,5                             |
| <b>MBRTA-48*</b>                        | 1200                             | 76,0                             |
| <b>MBRTA-60*</b>                        | 1500                             | 95,0                             |
| <b>MBRTA-72</b>                         | 1800                             | 87,0                             |
| <b>MBRTA-84</b>                         | 2100                             | 102,0                            |
| <b>MBRTA-96</b>                         | 2400                             | 116,0                            |
| <b>MBRTX-42</b>                         | 1050                             | 42,0                             |
| <b>MBRTX-48</b>                         | 1200                             | 48,0                             |

\* mit Metallkoffer · with Tool Box · avec coffret métallique

## Verbinder · Fasteners · Agrafes

| Material<br>Material<br>Matériel   | Bestell-Nr.<br>Order-No.<br>No. de réf. | Inhalt<br>Content<br>Contenu<br>m | Gewicht<br>Weight<br>Poids<br>kg |
|------------------------------------|---|-----------------------------------|----------------------------------|
| Stahl · Steel<br>Acier             | <b>BR-10</b>                            | 1,5                               | 3,63                             |
|                                    | <b>BR-14</b>                            | 1,5                               | 5,86                             |
| MegAlloy                           | <b>BR-10MA</b>                          | 1,5                               | 3,63                             |
|                                    | <b>BR-14MA</b>                          | 1,5                               | 5,86                             |
| Rostfrei · Stainless<br>Inoxydable | <b>BR-10S</b>                           | 1,5                               | 3,63                             |

## Ersatzteile und Zubehör Spare Parts and Accessories Pièces de rechange et accessoires

| Bestell-Nr.<br>Order-No.<br>No. de réf. | Gewicht<br>Weight<br>Poids<br>kg |
|---|----------------------------------|
| <b>BR500D</b>                           | 1,36                             |
| <b>BR151</b>                            | 0,23                             |

## Nieten Auswahltablelle Rivet Selection Chart Tableau de selection des rivets

| Verbinder<br>Fasteners<br>Agrafes | Bandstärke<br>Belt Thickness<br>Épaisseur de bande | Größe<br>Size<br>Largeur |
|-----------------------------------|--|--------------------------|
| <b>BR-10</b>                      | 6 - 8  | <b>SRA</b>               |
|                                   | 7 - 10   | <b>SRB</b>               |
|                                   | 9 - 11   | <b>SRC</b>               |
|                                   | 10 - 13  | <b>SRC/D</b>             |
|                                   | 12 - 14  | <b>SRD</b>               |
|                                   | 13 - 16  | <b>SRE</b>               |
|                                   | 15 - 17  | <b>SRF</b>               |
| <b>BR-14</b>                      | 10 - 13  | <b>SRD</b>               |
|                                   | 12 - 14  | <b>SRE</b>               |
|                                   | 13 - 16  | <b>SRF</b>               |
|                                   | 15 - 17  | <b>SRG</b>               |
|                                   | 16 - 19  | <b>SRH</b>               |
|                                   | 18 - 21  | <b>SRI</b>               |
|                                   | 20 - 22  | <b>SRJ</b>               |
|                                   | 21 - 24  | <b>SRK</b>               |

## Nieten pro Verbindung Rivets per Splice Rivets par jonction

| Bandbreite<br>Belt Width<br>Largeur de bande | BR-10 | BR-14 |
|--|-------|-------|
| 400  | 90    | 126   |
| 500  | 110   | 154   |
| 650  | 140   | 196   |
| 800  | 170   | 238   |
| 1000   | 220   | 308   |
| 1200   | 270   | 378   |
| 1400   | 310   | 434   |
| 1600   | 360   | 504   |
| 1800   | 410   | 574   |

Nieten siehe Seite 15

Rivets on page 15

Rivets sur la page 15

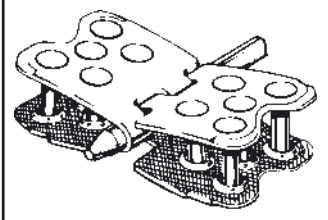

## FLEXCO Rivet Hinged

Transportband -  
Verbindungssystem  
für Bandstärken von  
5 bis 17 mm

Conveyor Belt Fastening  
System for Belts  
5 to 17 mm thick

Système d'agrafage pour  
bandes transporteuses  
d'épaisseur 5 - 17 mm

| Verbindergroße<br>Fastener Size<br>Taille des agrafes | Für Transportbänder bis zu... N/mm Festigkeit<br>For Belts with a Tensile Strength of up to... N/mm<br>Pour bandes tranporteuses à résistance<br>de rupture jusqu'à... N/mm | empf. Bandstärkenbereich<br>Belt Thickness Range<br>Épaisseur de bandes recommandée<br>mm | empf. kleinster Trommel-Ø<br>rec. min. Pulley-Ø<br>Ø tambour mini.rec.<br>mm |
|---|---|---|--|
| <b>R2</b>   | 400   | 6 - 10  | 125  |
| <b>R5</b>   | 800   | 6 - 11  | 200  |

**Inhalt:** Jeder Karton enthält 2 Verbinderstreifen für die angegebene Bandbreite. Niete und Kupplungsstäbe extra bestellen.

**Content:** Each Box contains two Fastener Strips for the Belt Width specified. Order Rivets and Hinge Pins separately.

**Contenu:** Chaque boîte contient deux bandes d'agrafes pour la largeur de bande spécifiée. Veuillez commander rivets et axes séparément.

### Stahl verzinkt Galvanized Steel / Acier galvanisé

| Bestell-Nr.<br>Order-No.<br>No. de réf. | Bandbreite<br>Belt Width<br>Largeur de Bande<br>mm | Gewicht<br>Weight<br>Poids<br>kg |
|---|--|----------------------------------|
| <b>R2-20/500</b>                        | 500  | 0,75                             |
| <b>R2-26/650</b>                        | 650  | 0,97                             |
| <b>R2-32/800</b>                        | 800  | 1,20                             |
| <b>R2-40/1000</b>                       | 1000   | 1,50                             |
| <b>R2-48/1200</b>                       | 1200   | 1,80                             |
| <b>R2-55/1400</b>                       | 1400   | 2,00                             |
| <b>R5-SE-20/500</b>                     | 500  | 1,27                             |
| <b>R5-SE-26/650</b>                     | 650  | 1,66                             |
| <b>R5-SE-32/800</b>                     | 800  | 2,20                             |
| <b>R5-SE-40/1000</b>                    | 1000   | 2,54                             |
| <b>R5-SE-48/1200</b>                    | 1200   | 3,13                             |
| <b>R5-SE-55/1400</b>                    | 1400   | 3,56                             |
| <b>R5-SE-63/1600</b>                    | 1600   | 4,10                             |

### MegAlloy

| Bestell-Nr.<br>Order-No.<br>No. de réf. | Inhalt<br>Content<br>Contenu | Gewicht<br>Weight<br>Poids<br>kg |
|---|------------------------------|----------------------------------|
| <b>R2MA</b>                             | 10 × 170 mm                  | 1,4                              |
| <b>R5MA-SE</b>                          | 10 × 170 mm                  | 2,2                              |
| <b>R5-1/2 MA-SE</b>                     | 10 × 170 mm                  | 2,8                              |

### Stahl verzinkt / Galvanized Steel / Acier galvanisé

**Inhalt:** Jeder J-Karton enthält eine komplette Verbindung mit Niete und NC-Kupplungsstab

**Content:** Each J-Box contains one complete splice with rivets and NC-hinge pin

**Contenu:** Chaque boîte J contient une jonction complète avec rivets et axe NC

| Bestell-Nr.<br>Order-No.<br>No. de réf. | Bandbreite<br>Belt Width<br>Largeur de Bande<br>mm | Gewicht<br>Weight<br>Poids<br>kg |
|---|--|----------------------------------|
| <b>R2J-20/500ANC</b>                    | 500  | 0,75                             |
| <b>R2J-26/650ANC</b>                    | 650  | 0,97                             |
| <b>R2J-32/800ANC</b>                    | 800  | 1,20                             |
| <b>R2J-40/1000ANC</b>                   | 1000   | 1,50                             |
| <b>R2J-48/1200ANC</b>                   | 1200   | 1,80                             |

Bandstärkenbereich/Belt Thickness Range/Épaisseur  
de bande recommandée R2J: 6 - 8 mm

### Rostfrei W.1.4401 / AISI 316 / Z6CND17-11 Stainless / Inoxydable

| Bestell-Nr.<br>Order-No.<br>No. de réf. | Bandbreite<br>Belt Width<br>Largeur de Bande<br>mm | Gewicht<br>Weight<br>Poids<br>kg |
|---|--|----------------------------------|
| <b>R2S-20/500</b>                       | 500  | 0,75                             |
| <b>R2S-26/650</b>                       | 650  | 0,97                             |
| <b>R2S-32/800</b>                       | 800  | 1,20                             |
| <b>R2S-40/1000</b>                      | 1000   | 1,50                             |
| <b>R2S-48/1200</b>                      | 1200   | 1,80                             |
| <b>R5S-SE-20/500</b>                    | 500  | 1,27                             |
| <b>R5S-SE-26/650</b>                    | 650  | 1,66                             |
| <b>R5S-SE-32/800</b>                    | 800  | 2,20                             |
| <b>R5S-SE-40/1000</b>                   | 1000   | 2,54                             |
| <b>R5S-SE-48/1200</b>                   | 1200   | 3,13                             |
| <b>R5S-SE-55/1400</b>                   | 1400   | 3,56                             |
| <b>R5S-SE-63/1600</b>                   | 1600   | 4,10                             |

### RustAlloy - W.1.4016 / AISI 430 / Z8C17 magnetisch / magnetic / magnétique

| Bestell-Nr.<br>Order-No.<br>No. de réf. | Inhalt<br>Content<br>Contenu | Gewicht<br>Weight<br>Poids<br>kg |
|---|------------------------------|----------------------------------|
| <b>RAR5-SE-26/650</b>                   | 650                          | 1,66                             |
| <b>RAR5-SE-32/800</b>                   | 800                          | 2,20                             |
| <b>RAR5-SE-40/1000</b>                  | 1000                         | 2,54                             |
| <b>RAR5-SE-48/1200</b>                  | 1200                         | 3,13                             |
| <b>RAR5-SE-55/1400</b>                  | 1400                         | 3,56                             |
| <b>RAR5-SE-63/1600</b>                  | 1600                         | 4,10                             |

| Bestell-Nr.<br>Order-No.<br>No. de réf. | Bandbreite<br>Belt Width<br>Largeur de Bande<br>mm | Gewicht<br>Weight<br>Poids<br>kg |
|---|--|----------------------------------|
| <b>R5J-SE-20/500NC</b>                  | 500  | 1,27                             |
| <b>R5J-SE-26/650NC</b>                  | 650  | 1,66                             |
| <b>R5J-SE-32/800NC</b>                  | 800  | 2,20                             |
| <b>R5J-SE-40/1000NC</b>                 | 1000   | 2,54                             |
| <b>R5J-SE-48/1200NC</b>                 | 1200   | 3,13                             |

Bandstärkenbereich/Belt Thickness Range/Épaisseur  
de bande recommandée R5J: 7 - 11 mm

| Verbindergroße<br>Fastener Size<br>Taille des agrafes | Für Transportbänder bis zu... N/mm Festigkeit<br>For Belts with a Tensile Strength of up to... N/mm<br>Pour bandes tranporteuses à résistance<br>de rupture jusqu'à... N/mm | empf. Bandstärkenbereich<br>Belt Thickness Range<br>Épaisseur de bandes recommandée<br>mm | empf. kleinster Trommel-Ø<br>rec. min. Pulley-Ø<br>Ø tambour mini.rec.<br>mm |
|---|---|---|--|
| <b>R5<sup>1/2</sup></b>                               | 1250  | 9 - 15  | 250  |
| <b>R6 / RAR6</b>                                      | 1400 / 1600   | 10 - 17   | 400  |
| <b>R8 / RAR8</b>                                      | 2000 / 2500   | 10 - 17   | 400  |
| <b>R9S</b>  | 3500  | 16 - 24   | 1050   |

**Inhalt:** Jeder Karton enthält 2 Verbinderstreifen für die angegebene Bandbreite. Nieten und Kupplungsstäbe extra bestellen.

**Content:** Each Box contains two Fastener Strips for the Belt Width specified. Order Rivets and Hinge Pins separately.

**Contenu:** Chaque boîte contient deux bandes d'agrafes pour la largeur de bande spécifiée. Veuillez commander rivets et axes séparément.

### Stahl verzinkt Galvanized Steel / Acier galvanisé

| Bestell-Nr.<br>Order-No.<br>No. de réf. | Bandbreite<br>Belt Width<br>Largeur de Bande<br>mm | Gewicht<br>Weight<br>Poids<br>kg |
|---|--|----------------------------------|
| <b>R5-<sup>1/2</sup>-SE-26/650</b>      | 650  | 2,40                             |
| <b>R5-<sup>1/2</sup>-SE-32/800</b>      | 800  | 2,95                             |
| <b>R5-<sup>1/2</sup>-SE-40/1000</b>     | 1000   | 3,68                             |
| <b>R5-<sup>1/2</sup>-SE-48/1200</b>     | 1200   | 4,49                             |
| <b>R5-<sup>1/2</sup>-SE-55/1400</b>     | 1400   | 5,16                             |
| <b>R5-<sup>1/2</sup>-SE-63/1600</b>     | 1600   | 5,89                             |
| <b>R5-<sup>1/2</sup>-SE-72/1800</b>     | 1800   | 6,63                             |
| <b>R6-SE-32/800</b>                     | 800  | 4,00                             |
| <b>R6-SE-40/1000</b>                    | 1000   | 5,00                             |
| <b>R6-SE-48/1200</b>                    | 1200   | 6,00                             |
| <b>R6-SE-55/1400</b>                    | 1400   | 7,00                             |
| <b>R6-SE-63/1600</b>                    | 1600   | 8,00                             |
| <b>R6-SE-72/1800</b>                    | 1800   | 9,00                             |
| <b>R8-SE-40/1000</b>                    | 1000   | 5,00                             |
| <b>R8-SE-48/1200</b>                    | 1200   | 6,00                             |
| <b>R8-SE-55/1400</b>                    | 1400   | 7,00                             |
| <b>R8-SE-63/1600</b>                    | 1600   | 8,00                             |
| <b>R8-SE-72/1800</b>                    | 1800   | 9,00                             |

### RustAlloy - W.1.4016 / AISI 430 / Z8C17 magnetisch / magnetic / magnétique

| Bestell-Nr.<br>Order-No.<br>No. de réf. | Bandbreite<br>Belt Width<br>Largeur de Bande<br>mm | Gewicht<br>Weight<br>Poids<br>kg |
|---|--|----------------------------------|
| <b>RAR5-<sup>1/2</sup>-SE-26/650</b>    | 650  | 2,40                             |
| <b>RAR5-<sup>1/2</sup>-SE-32/800</b>    | 800  | 2,95                             |
| <b>RAR5-<sup>1/2</sup>-SE-40/1000</b>   | 1000   | 3,68                             |
| <b>RAR5-<sup>1/2</sup>-SE-48/1200</b>   | 1200   | 4,49                             |
| <b>RAR5-<sup>1/2</sup>-SE-55/1400</b>   | 1400   | 5,16                             |
| <b>RAR5-<sup>1/2</sup>-SE-63/1600</b>   | 1600   | 5,89                             |
| <b>RAR5-<sup>1/2</sup>-SE-72/1800</b>   | 1800   | 6,63                             |
| <b>RAR6-SE-32/800</b>                   | 800  | 4,00                             |
| <b>RAR6-SE-40/1000</b>                  | 1000   | 5,00                             |
| <b>RAR6-SE-48/1200</b>                  | 1200   | 6,00                             |
| <b>RAR6-SE-55/1400</b>                  | 1400   | 7,00                             |
| <b>RAR6-SE-63/1600</b>                  | 1600   | 8,00                             |
| <b>RAR6-SE-72/1800</b>                  | 1800   | 9,00                             |
| <b>RAR8-SE-40/1000</b>                  | 1000   | 5,00                             |
| <b>RAR8-SE-48/1200</b>                  | 1200   | 6,00                             |
| <b>RAR8-SE-55/1400</b>                  | 1400   | 7,00                             |
| <b>RAR8-SE-63/1600</b>                  | 1600   | 8,00                             |
| <b>RAR8-SE-72/1800</b>                  | 1800   | 9,00                             |

### Rostfrei W.1.4401 / AISI 316 / Z6CND17-11 Stainless / Inoxydable

| Bestell-Nr.<br>Order-No.<br>No. de réf. | Bandbreite<br>Belt Width<br>Largeur de Bande<br>mm | Gewicht<br>Weight<br>Poids<br>kg |
|---|--|----------------------------------|
| <b>R9S-SE-40/1000</b>                   | 1000   | 6,50                             |
| <b>R9S-SE-48/1200</b>                   | 1200   | 7,70                             |
| <b>R9S-SE-55/1400</b>                   | 1400   | 9,00                             |
| <b>R9S-SE-63/1600</b>                   | 1600   | 10,00                            |
| <b>R9S-SE-72/1800</b>                   | 1800   | 11,50                            |

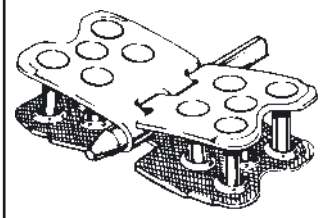

## FLEXCO Rivet Hinged

Kupplungsstäbe

Hinge Pins

Axes de jonction

### Stahl / Steel / Acier

| Bestell-Nr.<br>Order-No.<br>No. de réf. | Ø<br>mm                     | Verbinder<br>Fasteners<br>Agrafes | Bandbreite<br>Belt Width<br>Largeur de bande<br>mm |
|---|-----------------------------|-----------------------------------|--|
| <b>NC-500-1</b>                         | 6,3                         | R2, R5, 375, 550                  | 500  |
| <b>NC-650-1</b>                         |                             |                                   | 650  |
| <b>NC-800-1</b>                         |                             |                                   | 800  |
| <b>NC-1000-1</b>                        |                             |                                   | 1000   |
| <b>NC-1200-1</b>                        |                             |                                   | 1200   |
| <b>NC-1400-1</b>                        |                             |                                   | 1400   |
| <b>NC-1600-1</b>                        |                             |                                   | 1600   |
| <b>NC-C</b>                             | Rolle / Coil / Rouleau 30 m |                                   |  |
| <b>SC-500-1</b>                         | 6,0                         | R2, R5, 375, 550                  | 500  |
| <b>SC-650-1</b>                         |                             |                                   | 650  |
| <b>SC-800-1</b>                         |                             |                                   | 800  |
| <b>SC-1000-1</b>                        |                             |                                   | 1000   |
| <b>SC-1200-1</b>                        |                             |                                   | 1200   |
| <b>SC-C</b>                             | Rolle / Coil / Rouleau 30 m |                                   |  |
| <b>AC-500-1</b>                         | 6,3                         | R2, R5, 375, 550                  | 500  |
| <b>AC-650-1</b>                         |                             |                                   | 650  |
| <b>AC-800-1</b>                         |                             |                                   | 800  |
| <b>AC-1000-1</b>                        |                             |                                   | 1000   |
| <b>AC-1200-1</b>                        |                             |                                   | 1200   |
| <b>AC-1400-1</b>                        |                             |                                   | 1400   |
| <b>AC-1600-1</b>                        |                             |                                   | 1600   |
| <b>AC-3000-1</b>                        |                             |                                   | 3000   |
| <b>NAC-500-1</b>                        | 6,3                         | R2, R5, 375, 550                  | 500  |
| <b>NAC-650-1</b>                        |                             |                                   | 650  |
| <b>NAC-800-1</b>                        |                             |                                   | 800  |
| <b>NAC-1000-1</b>                       |                             |                                   | 1000   |
| <b>NAC-1200-1</b>                       |                             |                                   | 1200   |
| <b>NAC-1400-1</b>                       |                             |                                   | 1400   |
| <b>NAC-1600-1</b>                       |                             |                                   | 1600   |
| <b>AC6-650-1</b>                        | 9,6                         | R5-1/2, R6, R8                    | 650  |
| <b>AC6-800-1</b>                        |                             |                                   | 800  |
| <b>AC6-1000-1</b>                       |                             |                                   | 1000   |
| <b>AC6-1200-1</b>                       |                             |                                   | 1200   |
| <b>AC6-1400-1</b>                       |                             |                                   | 1400   |
| <b>AC6-1600-1</b>                       |                             |                                   | 1600   |
| <b>AC6-1800-1</b>                       |                             |                                   | 1800   |
| <b>NAC6-800-1</b>                       | 10,3                        | R5-1/2, R6, R8                    | 800  |
| <b>NAC6-1000-1</b>                      |                             |                                   | 1000   |
| <b>NAC6-1200-1</b>                      |                             |                                   | 1200   |
| <b>NAC6-1400-1</b>                      |                             |                                   | 1400   |
| <b>NAC6-1600-1</b>                      |                             |                                   | 1600   |
| <b>NAC6-1800-1</b>                      |                             |                                   | 1800   |
| <b>SC6-650-1</b>                        | 8,8                         | R5-1/2, R6, R8                    | 650  |
| <b>SC6-800-1</b>                        |                             |                                   | 800  |
| <b>SC6-1000-1</b>                       |                             |                                   | 1000   |
| <b>SC6-1200-1</b>                       |                             |                                   | 1200   |
| <b>SC6-1400-1</b>                       |                             |                                   | 1400   |
| <b>SC6-1600-1</b>                       |                             |                                   | 1600   |

### Rostfrei / Stainless / Inoxydable

| Bestell-Nr.<br>Order-No.<br>No. de réf.                  | Ø<br>mm                     | Verbinder<br>Fasteners<br>Agrafes | Bandbreite<br>Belt Width<br>Largeur de bande<br>mm |
|--|-----------------------------|-----------------------------------|--|
| <b>NCS-500-1</b>   | 6,3                         | R2, R5, 375, 550                  | 500  |
| <b>NCS-650-1</b>   |                             |                                   | 650  |
| <b>NCS-800-1</b>   |                             |                                   | 800  |
| <b>NCS-1000-1</b>  |                             |                                   | 1000   |
| <b>NCS-1200-1</b>  |                             |                                   | 1200   |
| <b>NCS-1400-1</b>  |                             |                                   | 1400   |
| <b>NCS-1600-1</b>  |                             |                                   | 1600   |
| <b>NCS-C</b>   | Rolle / Coil / Rouleau 30 m |                                   |  |
| <b>SSC-500-1</b>   | 6,0                         | R2, R5, 375, 550                  | 500  |
| <b>SSC-650-1</b>   |                             |                                   | 650  |
| <b>SSC-800-1</b>   |                             |                                   | 800  |
| <b>SSC-1000-1</b>  |                             |                                   | 1000   |
| <b>SSC-1200-1</b>  |                             |                                   | 1200   |
| <b>ACS-500-1</b>   | 6,3                         | R2, R5, 375, 550                  | 500  |
| <b>ACS-650-1</b>   |                             |                                   | 650  |
| <b>ACS-800-1</b>   |                             |                                   | 800  |
| <b>ACS-1000-1</b>  |                             |                                   | 1000   |
| <b>ACS-1200-1</b>  |                             |                                   | 1200   |
| <b>ACS-1400-1</b>  |                             |                                   | 1400   |
| <b>ACS-1600-1</b>  |                             |                                   | 1600   |
| <b>ACS-3000-1</b>  |                             |                                   | 3000   |
| <b>ACS6-650-1</b>  | 9,6                         | R5-1/2, R6, R8                    | 650  |
| <b>ACS6-800-1</b>  |                             |                                   | 800  |
| <b>ACS6-1000-1</b>                                       |                             |                                   | 1000   |
| <b>ACS6-1200-1</b>                                       |                             |                                   | 1200   |
| <b>ACS6-1400-1</b>                                       |                             |                                   | 1400   |
| <b>ACS6-1600-1</b>                                       |                             |                                   | 1600   |
| <b>ACS6-1800-1</b>                                       |                             |                                   | 1800   |
| <b>NCS962-1200-1</b>                                     |                             | R9                                | 1200   |
| <b>NCS962-1400-1</b>                                     |                             |                                   | 1400   |
| <b>NCS962-1600-1</b>                                     |                             |                                   | 1600   |
| <b>NCS962-1800-1</b>                                     |                             |                                   | 1800   |
| <b>NCS975-1200-1</b>                                     |                             | R9                                | 1200   |
| <b>NCS975-1400-1</b>                                     |                             |                                   | 1400   |
| <b>NCS975-1600-1</b>                                     |                             |                                   | 1600   |
| <b>NCS975-1800-1</b>                                     |                             |                                   | 1800   |
| <b>Antimagnetisch / Non magnetic<br/>Anti-magnétique</b> |                             |                                   |  |
| <b>NB-500-1</b>  | 6,3                         | R2, R5, 375, 550                  | 500  |
| <b>NB-650-1</b>  |                             |                                   | 650  |
| <b>NB-800-1</b>  |                             |                                   | 800  |
| <b>NB-1000-1</b>   |                             |                                   | 1000   |
| <b>NB-1200-1</b>   |                             |                                   | 1200   |
| <b>NB-C</b>  | Rolle / Coil / Rouleau 30 m |                                   |  |

**Nieten Auswahltablelle**  
**Rivet Selection Chart**  
**Tableau de selection des rivets**

| Verbinder<br>Fasteners<br>Agrafes | Bandstärke<br>Belt Thickness<br>Epaisseur de bande | Größe<br>Size<br>Largeur |
|-----------------------------------|--|--------------------------|
| <b>R2</b>                         | 5 - 6  | <b>SRAA</b>              |
|                                   | 6 - 8  | <b>SRA</b>               |
|                                   | 7 - 10   | <b>SRB</b>               |
| <b>R5</b>                         | 6 - 8  | <b>SRA</b>               |
|                                   | 7 - 10   | <b>SRB</b>               |
|                                   | 9 - 11   | <b>SRC</b>               |
| <b>R5-1/2</b>                     | 8 - 9  | <b>SRB</b>               |
|                                   | 9 - 10,5   | <b>SRC</b>               |
|                                   | 10 - 12  | <b>SRC/D</b>             |
|                                   | 11 - 13,5  | <b>SRD</b>               |
|                                   | 13 - 15  | <b>SRE</b>               |
| <b>R6 / R8</b>                    | 9 - 11   | <b>SRC/D</b>             |
|                                   | 10,5 - 13  | <b>SRD</b>               |
|                                   | 12 - 14  | <b>SRE</b>               |
|                                   | 13,5 - 16  | <b>SRF</b>               |
|                                   | 15 - 17  | <b>SRG</b>               |
| <b>R9S</b>                        | 16,5 - 19  | <b>SRH</b>               |
|                                   | 18 - 21  | <b>SRI</b>               |
|                                   | 20 - 22  | <b>SRJ</b>               |
|                                   | 21 - 24  | <b>SRK</b>               |

**FLEXCO Rapid Loader-Nieten · Rivets · Rivets**

Inhalt 60 Streifen / 1200 Nieten pro Eimer  
 Content 60 strips / 1200 rivets per bucket  
 Contenu 60 bandes / 1200 rivets par seau

| Bestell-Nr.<br>Order-No.<br>No. de réf. | Größe<br>Size<br>Taille | Farbe<br>Colour<br>Couleur | Gewicht<br>Weight<br>Poids<br>kg |
|---|-------------------------|----------------------------|----------------------------------|
|---|-------------------------|----------------------------|----------------------------------|

**Stahl / Steel / Acier**

|                |     |                    |      |
|----------------|-----|--------------------|------|
| <b>CSRLA</b>   | A   | Rot/Red/Rouge      | 5,89 |
| <b>CSRLB</b>   | B   | Weiß/White/Blanc   | 6,31 |
| <b>CSRLC</b>   | C   | Blau/Blue/Bleu     | 6,72 |
| <b>CSRLC/D</b> | C/D | Orange             | 7,05 |
| <b>CSRLD</b>   | D   | Grün/Green/Vert    | 7,28 |
| <b>CSRLE</b>   | E   | Lila/Purple/Lilas  | 7,53 |
| <b>CSRLF</b>   | F   | Gelb/Yellow/Jaune  | 7,86 |
| <b>CSRLG</b>   | G   | Schwarz/Black/Noir | 8,11 |

**Rostfrei / Stainless / Inoxydable**

|                  |     |                    |      |
|------------------|-----|--------------------|------|
| <b>CSRLA-S</b>   | A   | Rot/Red/Rouge      | 5,84 |
| <b>CSRLB-S</b>   | B   | Weiß/White/Blanc   | 6,25 |
| <b>CSRLC-S</b>   | C   | Blau/Blue/Bleu     | 6,76 |
| <b>CSRLC/D-S</b> | C/D | Orange             | 6,94 |
| <b>CSRLD-S</b>   | D   | Grün/Green/Vert    | 7,21 |
| <b>CSRLE-S</b>   | E   | Lila/Purple/Lilas  | 7,47 |
| <b>CSRLF-S</b>   | F   | Gelb/Yellow/Jaune  | 7,67 |
| <b>CSRLG-S</b>   | G   | Schwarz/Black/Noir | 7,94 |

**Nieten pro Verbindung**  
**Rivets per Splice**  
**Rivets par jonction**

| Bandbreite<br>Belt Width<br>Largeur de bande | Platten<br>Plates<br>Plaques | R2  | R5, 5-1/2, R6 | R8/R9S |
|--|------------------------------|-----|---------------|--------|
| 400  | 9                            | 36  | 90            |        |
| 500  | 11                           | 44  | 110           |        |
| 650  | 14                           | 56  | 140           |        |
| 800  | 18                           | 72  | 180           |        |
| 1000   | 22                           | 88  | 220           | 352    |
| 1200   | 27                           | 108 | 270           | 432    |
| 1400   | 31                           | 124 | 310           | 496    |
| 1600   | 36                           | 144 | 360           | 576    |
| 1800   | 41                           | 164 | 410           | 656    |

**FLEXCO-Nieten · Rivets · Rivets**

| Bestell-Nr.<br>Order-No.<br>No. de réf. | Größe<br>Size<br>Largeur | Inhalt<br>Content<br>Contenu | Gewicht<br>Weight<br>Poids<br>kg |
|---|--------------------------|------------------------------|----------------------------------|
|---|--------------------------|------------------------------|----------------------------------|

**Stahl / Steel / Acier**

|              |       |     |      |
|--------------|-------|-----|------|
| <b>SRAA</b>  | SRAA  | 250 | 1,00 |
| <b>SRA</b>   | SRA   | 250 | 1,04 |
| <b>SRB</b>   | SRB   | 250 | 1,13 |
| <b>SRC</b>   | SRC   | 250 | 1,18 |
| <b>SRC/D</b> | SRC/D | 250 | 1,27 |
| <b>SRD</b>   | SRD   | 250 | 1,32 |
| <b>SRE</b>   | SRE   | 250 | 1,41 |
| <b>SRF</b>   | SRF   | 250 | 1,41 |
| <b>SRG</b>   | SRG   | 250 | 1,45 |
| <b>SRH</b>   | SRH   | 250 | 1,54 |
| <b>SRI</b>   | SRI   | 250 | 1,65 |
| <b>SRJ</b>   | SRJ   | 250 | 1,73 |
| <b>SRK</b>   | SRK   | 250 | 1,85 |

|                 |       |      |       |
|-----------------|-------|------|-------|
| <b>SRA-2M</b>   | SRA   | 2000 | 7,52  |
| <b>SRB-2M</b>   | SRB   | 2000 | 8,20  |
| <b>SRC-2M</b>   | SRC   | 2000 | 9,15  |
| <b>SRC/D-2M</b> | SRC/D | 2000 | 9,60  |
| <b>SRD-2M</b>   | SRD   | 2000 | 9,92  |
| <b>SRE-2M</b>   | SRE   | 2000 | 10,46 |
| <b>SRF-2M</b>   | SRF   | 2000 | 11,05 |
| <b>SRG-2M</b>   | SRG   | 2000 | 11,28 |

**Rostfrei W.1.4016 / magnetisch**  
**Stainless AISI 430 / magnetic**  
**Inoxydable Z8C17 / magnétique**

|                |       |     |      |
|----------------|-------|-----|------|
| <b>SRAA-S</b>  | SRAA  | 250 | 1,00 |
| <b>SRA-S</b>   | SRA   | 250 | 1,04 |
| <b>SRB-S</b>   | SRB   | 250 | 1,13 |
| <b>SRC-S</b>   | SRC   | 250 | 1,18 |
| <b>SRC/D-S</b> | SRC/D | 250 | 1,27 |
| <b>SRD-S</b>   | SRD   | 250 | 1,32 |
| <b>SRE-S</b>   | SRE   | 250 | 1,41 |
| <b>SRF-S</b>   | SRF   | 250 | 1,41 |
| <b>SRG-S</b>   | SRG   | 250 | 1,45 |

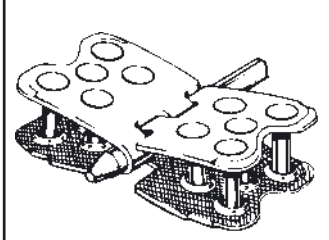

## FLEXCO Rivet Hinged

Montagegeräte

Installation Tools

Outillage de montage

| Bestell-Nr.<br>Order-No.<br>No. de réf. | Breite<br>Width<br>Largeur<br>mm | Gewicht<br>Weight<br>Poids<br>kg |
|---|----------------------------------|----------------------------------|
| <b>R2T</b>                              | 300                              | 3,00                             |
| <b>MSRTX-30</b>                         | 750                              | 23,00                            |
| <b>MSRTX-36</b>                         | 900                              | 25,00                            |
| <b>MSRTX-42</b>                         | 1050                             | 27,00                            |
| <b>MSRTX-48</b>                         | 1200                             | 29,00                            |
| <b>MSRTX-60</b>                         | 1500                             | 31,00                            |
| <b>MSRTX-12-AL</b>                      | 300                              | 10,00                            |
| <b>MSRTX-30-AL</b>                      | 750                              | 23,00                            |
| <b>MSRTX-36-AL</b>                      | 900                              | 25,00                            |
| <b>MSRTX-42-AL</b>                      | 1050                             | 27,00                            |
| <b>MSRTX-48-AL</b>                      | 1200                             | 29,00                            |
| <b>MSRTX-60-AL</b>                      | 1500                             | 31,00                            |
| <b>MSRT-30E-AL*</b>                     | 750                              | 39,00                            |
| <b>MSRT-36E-AL*</b>                     | 900                              | 44,00                            |
| <b>MSRT-42E-AL*</b>                     | 1050                             | 49,00                            |
| <b>MSRT-48E-AL*</b>                     | 1200                             | 54,00                            |
| <b>MSRT-60E-AL*</b>                     | 1500                             | 71,00                            |
| <b>MSRT-72-AL</b>                       | 1800                             | 46,00                            |
| <b>MSRT8-48</b>                         | 1200                             | 38,50                            |
| <b>MSRT8-60</b>                         | 1500                             | 42,00                            |
| <b>MSRT8-72</b>                         | 1800                             | 46,00                            |
| <b>MSRT8-84</b>                         | 2100                             | 50,00                            |
| <b>MSRT8-48E*</b>                       | 1200                             | 54,00                            |
| <b>MSRT8-60E*</b>                       | 1500                             | 69,00                            |
| <b>MSRT9-48</b>                         | 1200                             | 40,00                            |
| <b>MSRT9-60</b>                         | 1500                             | 42,00                            |
| <b>MSRT9-72</b>                         | 1800                             | 45,00                            |
| <b>MSRT9-84</b>                         | 2100                             | 50,00                            |

### Montagegeräte / Installation Tools / Outillage de montage

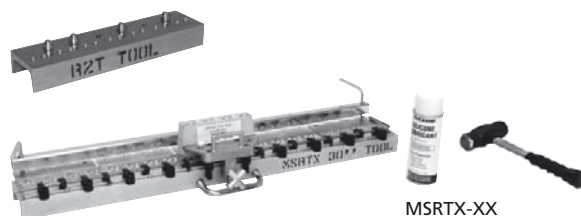

MSRTX-XX

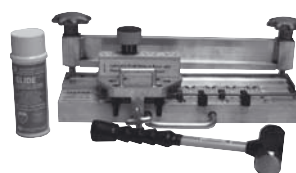

MSRTX-XX-AL



MSRTX-XXE-AL

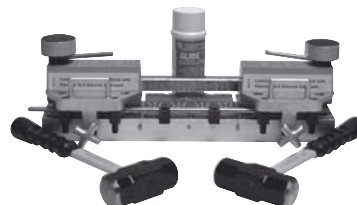

MSRT8-XX / MSRT9-XX

\* mit Metallkoffer / with Tool Box / avec coffret métallique



Nietentreiber für Bosch-Schlaghammer  
EPRD-DR

Drive Rod for Bosch  
Demolition Hammer  
EPRD-DR

Chasoir rivets pour  
Marteau piqueur Bosch  
EPRD-DR



Schlaghammer  
BOSCH GSH5E

Demolition Hammer  
BOSCH GSH5E

Marteau pneumatique  
BOSCH GSH5E



Ersatzteile  
und Zubehör

Spare Parts and  
Accessories

Pièces de rechange  
et accessoires

| Bestell-Nr.<br>Order-No.<br>No. de réf.  |   | Gewicht<br>Weight<br>Poids<br>kg |
|--|---|----------------------------------|
| <b>SR700</b>   | Führungsblock/Guide Block/Bloc de guidage<br>R5, R 5½, R6   | 1,36                             |
| <b>SR800</b>   | Führungsblock/Guide Block/Bloc de guidage<br>R8, R9S  | 1,36                             |
| <b>SR759</b>   | Nietentreiber/Drive Rod/Chassoir de rivets<br>R5, R 5½, R6  | 0,44                             |
| <b>SR759-2</b>   | Nietentreiber/Drive Rod/Chassoir de rivets<br>R2  | 0,40                             |
| <b>SR859-8</b>   | Nietentreiber/Drive Rod/Chassoir de rivets<br>R8, R9S   | 0,50                             |
| <b>4FH</b>   | Hammer/Hammer/Marteau   | 2,00                             |
| <b>SL5-1</b>   | Silikonspray/Silicone Spray/Silicone  | 0,62                             |
| <b>SR50</b>  | Einzelnietentreiber komplett<br>Individual Drive Rod complete<br>Chassoir pour rivets individuels complet | 0,35                             |
| <b>SR5-7</b>   | Treiberstift/Drive Pin/Tige de chassoir   | 0,03                             |
| <b>SR-CB</b>   | Kanvastasche/Canvas Bag/Poche de canevas  | 0,60                             |
| <b>Extra Metallkoffer / Extra Tool Box<br/>Coffret métallique supplémentaire</b> |   |                                  |
| <b>TB900</b>   |   | 17,50                            |
| <b>TB1200</b>  |   | 18,50                            |
| <b>TB1500</b>  |   | 22,50                            |



SR759 (R5 / R5½ / R6)  
SR759-2 (R2)

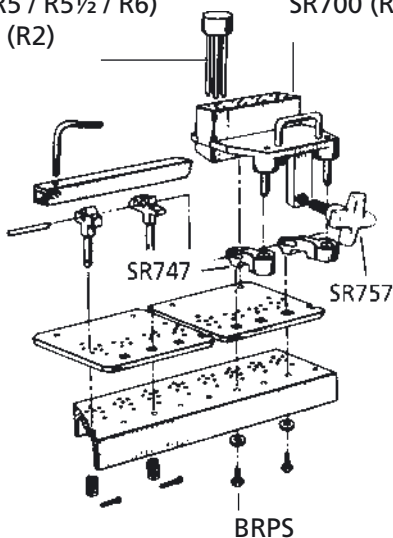

SR700 (R5 / R5½ / R6)

| Bestell-Nr.<br>Order-No.<br>No. de réf. |   | Gewicht<br>Weight<br>Poids<br>kg |
|---|---|----------------------------------|
| <b>SR24</b>                             | Halterung/Gauge Pin Guide/Fixation  | 0,04                             |
| <b>SR25</b>                             | Halterung/Gauge Pin Guide/Fixation  | 0,04                             |
| <b>SR22A</b>                            | Amboßplatte komplett/Anvil Plate<br>complete / Plaque d'enclume complète            | 0,80                             |
| <b>SR23</b>                             | Fixierschraube komplett/Tightening Bolt<br>complete / Vis de fixation complète      | 0,10                             |
| <b>SR757</b>                            | Fixierschraube/Clamping Screw/<br>Vis de fixation                                   | 0,25                             |
| <b>SR747</b>                            | Nietenführungseinheit<br>Rivet Guide Locator Assembly<br>Unité de guidage de rivets | 0,10                             |
| <b>BRPS</b>                             | Schrauben / Screws / Vis (50)   | 0,31                             |
| <b>SR5-1</b>                            | Schraubhülsen 2er-Set / Collets Set of 2<br>Douilles jeu de 2                       | 0,04                             |
| <b>SR2-30</b>                           | Steckstift für / Gauge Pin for / Goupille pour<br>MSRT-30 / MSRTX-30                |                                  |
| <b>SR2-36</b>                           | MSRT-36 / MSRTX-36  |                                  |
| <b>SR2-42</b>                           | MSRT-42 / MSRTX-42  |                                  |
| <b>SR2-48</b>                           | MSRT-48 / MSRTX-48  |                                  |
| <b>SR2-60</b>                           | MSRT-60 / MSRTX-60  |                                  |
| <b>SR2-72</b>                           | MSRT-72 / MSRTX-72  |                                  |
| <b>SR2-84</b>                           | MSRT-84 / MSRTX-84  |                                  |
| <b>SR9-30</b>                           | Klemmschiene für/Clamp Bar for/<br>Dispositif de serrage pour MSRT-30 / MSRTX-30    |                                  |
| <b>SR9-36</b>                           | MSRT-36 / MSRTX-36  |                                  |
| <b>SR9-42</b>                           | MSRT-42 / MSRTX-42  |                                  |
| <b>SR9-48</b>                           | MSRT-48 / MSRTX-48  |                                  |
| <b>SR9-60</b>                           | MSRT-60 / MSRTX-60  |                                  |
| <b>SR9-72</b>                           | MSRT-72 / MSRTX-72  |                                  |
| <b>SR9-84</b>                           | MSRT-84 / MSRTX-84  |                                  |
| <b>R5-RAR6LP</b>                        | Lehre zur Nietenauswahl / Rivet Gauge /<br>Gabarit pour sélection des rivets        |                                  |
| <b>R6-R8</b>                            | Lehre zur Nietenauswahl / Rivet Gauge<br>Gabarit pour sélection des rivets          |                                  |

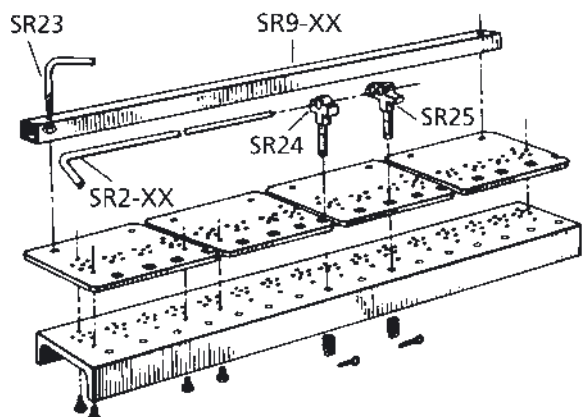
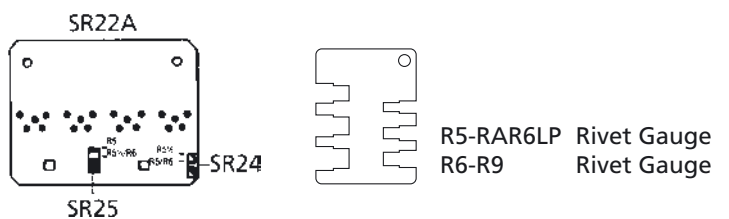

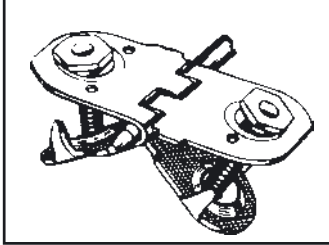

## FLEXCO Bolt Hinged

Transportband -  
Verbindungssystem für  
Bandstärken  
von 6 bis 16 mm

Conveyor Belt Fastening  
System for Belts  
6 to 16 mm thick

Système d'agrafage pour  
bandes transporteuses  
d'épaisseur 6 - 16 mm

| Verbindergröße<br>Fastener Size<br>Taille des agrafes | Für Transportbänder bis zu... N/mm Festigkeit<br>For Belts with a Tensile Strength of up to... N/mm<br>Pour bandes tranporteuses à résistance<br>de rupture jusqu'à... N/mm | empf. Bandstärkenbereich<br>Belt Thickness Range<br>Épaisseur de bandes recommandée<br>mm | empf. kleinster Trommel-Ø<br>rec. min. Pulley-Ø<br>Ø tambour mini.rec.<br>mm |
|---|---|---|--|
| <b>375X</b>   | 400   | 6 - 10  | 125  |
| <b>550</b>  | 500   | 6 - 16  | 200  |

**Inhalt:** Jeder J-Karton enthält 1 komplette Verbindung für die angegebene Bandbreite.

**Content:** Each J-Box contains 1 Set Lacing for the Belt Width specified.

**Contenu:** Chaque boîte J contient 1 jeu complet de jonction pour la largeur de bande spécifiée.

### Stahl verzinkt Galvanized Steel / Acier galvanisé

| Bestell-Nr.<br>Order-No.<br>No. de réf. | Bandbreite<br>Belt Width<br>Larg. de bande<br>mm | Gewicht<br>Weight<br>Poids<br>kg |
|---|--|----------------------------------|
| <b>375XJ400NC-SN</b>                    | 400  | 1,28                             |
| <b>375XJ500NC-SN</b>                    | 500  | 1,59                             |
| <b>375XJ650NC-SN</b>                    | 650  | 2,07                             |
| <b>375XJ800NC-SN</b>                    | 800  | 2,55                             |
| <b>375XJ1000NC-SN</b>                   | 1000   | 3,18                             |
| <b>375XJ1200NC-SN</b>                   | 1200   | 3,77                             |
| <b>375XJ1400NC-SN</b>                   | 1400   | 4,46                             |
| <b>550J500NC-SN</b>                     | 500  | 1,66                             |
| <b>550J650NC-SN</b>                     | 650  | 2,16                             |
| <b>550J800NC-SN</b>                     | 800  | 2,66                             |
| <b>550J1000NC-SN</b>                    | 1000   | 3,32                             |
| <b>550J1200NC-SN</b>                    | 1200   | 4,00                             |
| <b>550J1400NC-SN</b>                    | 1400   | 4,65                             |

### MegAlloy

|                        |      |     |
|------------------------|------|-----|
| <b>550MAJ650SC-SN</b>  | 650  | 2,1 |
| <b>550MAJ800SC-SN</b>  | 800  | 2,7 |
| <b>550MAJ1000SC-SN</b> | 1000 | 3,3 |
| <b>550MAJ1200SC-SN</b> | 1200 | 4,0 |

### Lose-Verbinder (mit Schrauben und Muttern) Bulk Fasteners (with Bolts and Nuts) Plaques d'agrafes individuelles (avec vis et écrous)

#### Stahl / Steel / Acier

| Bestell-Nr.<br>Order-No.<br>No. de réf. | Platten<br>Plates<br>Plaques | Sets/Eimer<br>Sets/Box<br>Jeux/seau | Gewicht<br>Weight<br>Poids<br>kg |
|---|------------------------------|-------------------------------------|----------------------------------|
| <b>375X-3-SN</b>                        | 3                            | 18                                  | 3,86                             |
| <b>550-1-SN</b>                         | 1                            | 50                                  | 5,44                             |
| <b>550-3-SN</b>                         | 3                            | 18                                  | 5,90                             |

Extra Kupplungsstäbe auf Seite 14  
Extra Hinge Pins on Page 14  
Axes de jonction supplémentaires page 14

### Rostfrei Stainless / Inoxydable

| Bestell-Nr.<br>Order-No.<br>No. de réf. | Bandbreite<br>Belt Width<br>Larg. de bande<br>mm | Gewicht<br>Weight<br>Poids<br>kg |
|---|--|----------------------------------|
| <b>375XSJ400NCS</b>                     | 400  | 1,28                             |
| <b>375XSJ500NCS</b>                     | 500  | 1,59                             |
| <b>375XSJ650NCS</b>                     | 650  | 2,07                             |
| <b>375XSJ800NCS</b>                     | 800  | 2,55                             |
| <b>375XSJ1000NCS</b>                    | 1000   | 3,18                             |
| <b>375XSJ1200NCS</b>                    | 1200   | 3,77                             |
| <b>375XSJ1400NCS</b>                    | 1400   | 4,46                             |
| <b>550SJ500SSC</b>                      | 500  | 1,66                             |
| <b>550SJ650SSC</b>                      | 650  | 2,16                             |
| <b>550SJ800SSC</b>                      | 800  | 2,66                             |
| <b>550SJ1000SSC</b>                     | 1000   | 3,32                             |
| <b>550SJ1200SSC</b>                     | 1200   | 4,00                             |
| <b>550SJ1400SSC</b>                     | 1400   | 4,65                             |

### Antimagnetisch / Non magnetic / Anti-magnétique







|                     |      |      |
|---------------------|------|------|
| <b>375XEJ500NB</b>  | 500  | 1,59 |
| <b>375XEJ650NB</b>  | 650  | 2,07 |
| <b>375XEJ800NB</b>  | 800  | 2,55 |
| <b>375XEJ1000NB</b> | 1000 | 3,18 |
| <b>375XEJ1200NB</b> | 1200 | 3,77 |
| <b>550SJ650NB</b>   | 650  | 2,16 |
| <b>550SJ800NB</b>   | 800  | 2,66 |
| <b>550SJ1000NB</b>  | 1000 | 3,32 |
| <b>550SJ1200NB</b>  | 1200 | 4,00 |
| <b>550SJ1400NB</b>  | 1400 | 4,50 |

### Rostfrei / Stainless / Inoxydable

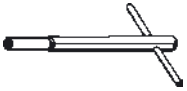
| Bestell-Nr.<br>Order-No.<br>No. de réf. | Platten<br>Plates<br>Plaques | Sets/Krt.<br>Sets/Box<br>Jeux/bte. | Gewicht<br>Weight<br>Poids<br>kg |
|---|------------------------------|------------------------------------|----------------------------------|
| <b>375XS-2</b>                          | 2                            | 25                                 | 2,86                             |
| <b>375XS-3</b>                          | 3                            | 18                                 | 3,68                             |
| <b>550S-1</b>                           | 1                            | 50                                 | 5,49                             |

Extra Schrauben und Muttern auf Seite 23  
Extra Bolts and Nuts on Page 23  
Vis et écrous supplémentaires page 23

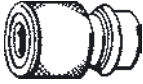
## Montagewerkzeuge · Installation Tools · Outils de montage

|  |  | Bestell-Nr.<br>Order-No.<br>No. de réf. | Verbindergroße<br>Fastener Size<br>Taille d'agrafe | Gewicht<br>Weight<br>Poids<br>kg |
|--|--|---|--|----------------------------------|
| <b>Manuelle Montage · Hand Tools · Montage manuel</b>                              |  |   |  |                                  |
|    | Schraubendreher<br>Bolt Breaker<br>Casse-vis                                     | <b>110</b>                              | 375 + 550  | 0,60                             |
|    | Lochisen<br>Punch<br>Poinçon   | <b>P1P</b>                              | 375 + 550  | 0,06                             |
|    | Schraubenschlüssel<br>Wrench<br>Clé à tube                                       | <b>S1S</b>                              | 375 + 550  | 0,09                             |
| <b>Für Schlagschrauber · Power Tools · Outils pour boulonneuse à percussion</b>    |  |   |  |                                  |
|    | Lochisen<br>Punch<br>Poinçon   | <b>HP1</b>                              | 375 + 550  | 0,07                             |
|  | Schraubenschlüssel<br>Wrench<br>Clé à tube                                       | <b>HW1</b>                              | 375 + 550  | 0,11                             |
|  | Schnellkupplung<br>Quick Change Chuck<br>Mandrin serrage rapide                  | <b>5552</b>                             | 375 + 550  | 0,16                             |
|  | Füllschlauch orange (30 m)<br>Orange Filler Tubing (30 m)<br>Tuyau orange (30 m) | <b>30894</b>                            | 375 + 550  | 0,36                             |

## Bohrschablonen · Templets · Gabarits

| Bestell-Nr.<br>Order-No.<br>No. de réf. | Bandbreite<br>Belt Width<br>Largeur de bande<br>mm | Gewicht<br>Weight<br>Poids<br>kg | Bestell-Nr.<br>Order-No.<br>No. de réf. | Bandbreite<br>Belt Width<br>Largeur de bande<br>mm | Gewicht<br>Weight<br>Poids<br>kg |
|---|--|----------------------------------|---|--|----------------------------------|
| <b>für/for/pour 375</b>                 |  |                                  | <b>für/for/pour 550</b>                 |  |                                  |
| <b>375X-500</b>                         | 500  | 1,05                             | <b>5-500</b>                            | 500  | 1,05                             |
| <b>375X-650</b>                         | 650  | 1,36                             | <b>5-650</b>                            | 650  | 1,36                             |
| <b>375X-800</b>                         | 800  | 1,68                             | <b>5-800</b>                            | 800  | 1,68                             |
| <b>375X-1000</b>                        | 1000   | 2,09                             | <b>5-1000</b>                           | 1000   | 2,09                             |
| <b>375X-1200</b>                        | 1200   | 2,51                             | <b>5-1200</b>                           | 1200   | 2,51                             |
| <b>375X-1400</b>                        | 1400   | 2,93                             | <b>5-1400</b>                           | 1400   | 2,93                             |

## Bandschneider, Serie 400 Belt Cutter 400 Series Coupeuse de bande Série 400

|               |      |       |
|---------------|------|-------|
| <b>400430</b> | 750  | 6,42  |
| <b>400436</b> | 900  | 7,32  |
| <b>400442</b> | 1050 | 8,59  |
| <b>400448</b> | 1200 | 8,62  |
| <b>400460</b> | 1500 | 10,43 |

## FLEXCO-LOK Band FLEXCO-LOK Tape Bande FLEXCO-LOK

| Bestell-Nr.<br>Order-No.<br>No. de réf. | für<br>for<br>pour | Länge<br>Length<br>Longueur<br>m | Gewicht<br>Weight<br>Poids<br>kg |
|---|--------------------|----------------------------------|----------------------------------|
| <b>FL7C</b>                             | 375X/550           | 30                               | 0,36                             |

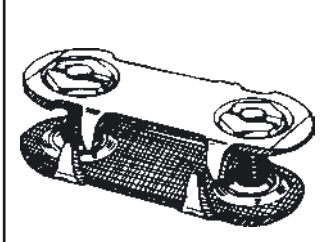

## FLEXCO Bolt Solid Plate

Transportband -  
Verbindungssystem für  
Bandstärken  
von 5 bis 30 mm

Conveyor Belt Fastening  
System for Belts  
5 to 30 mm thick

Système d'agrafage pour  
bandes transporteuses  
d'épaisseur 5 - 30 mm

| Verbindergroße<br>Fastener Size<br>Taille des agrafes | Für Transportbänder bis zu... N/mm Festigkeit<br>For Belts with a Tensile Strength of up to... N/mm<br>Pour bandes tranporteuses à résistance<br>de rupture jusqu'à... N/mm | empf. Bandstärkenbereich<br>Belt Thickness Range<br>Épaisseur de bandes recommandée<br>mm | empf. kleinster Trommel-Ø<br>rec. min. Pulley-Ø<br>Ø tambour mini.rec.<br>mm |
|---|---|---|--|
| <b>1</b>  | 315   | 5 - 11  | 250  |
| <b>140</b>  | 400   | 5 - 11  | 300  |
| <b>190</b>  | 630   | 8 - 14  | 400  |
| <b>1-1/2</b>  | 500   | 11 - 17   | 400  |
| <b>2</b>  | 800   | 14 - 21   | 700  |
| <b>2-1/4</b>  | 1000  | 14 - 30   | 850  |
| <b>2-1/2</b>  | 800   | 19 - 25   | 1000   |
| <b>3</b>  | 1000  | 24 +  | 1200   |

| Bestell-Nr.<br>Order-No.<br>No. de réf. | Inhalt<br>Content<br>Contenu | Gewicht<br>Weight<br>Poids<br>kg | Bestell-Nr.<br>Order-No.<br>No. de réf. | Inhalt<br>Content<br>Contenu | Gewicht<br>Weight<br>Poids<br>kg |
|---|------------------------------|----------------------------------|---|------------------------------|----------------------------------|
|---|------------------------------|----------------------------------|---|------------------------------|----------------------------------|

### E-Stahl / Steel / Acier

|               |    |      |
|---------------|----|------|
| <b>1E</b>     | 25 | 1,32 |
| <b>140E</b>   | 25 | 2,08 |
| <b>190E</b>   | 25 | 2,17 |
| <b>1-1/2E</b> | 25 | 2,68 |
| <b>2E</b>     | 25 | 3,63 |
| <b>2-1/4E</b> | 25 | 4,89 |
| <b>2-1/2E</b> | 10 | 2,90 |
| <b>3</b>      | 10 | 3,18 |

### C-Stahl / Steel / Acier

|               |     |       |
|---------------|-----|-------|
| <b>1C</b>     | 100 | 4,94  |
| <b>140C</b>   | 100 | 7,12  |
| <b>190C</b>   | 100 | 8,39  |
| <b>1-1/2C</b> | 100 | 9,93  |
| <b>2C</b>     | 100 | 13,74 |
| <b>2-1/4C</b> | 100 | 19,18 |
| <b>2-1/2C</b> | 100 | 29,03 |
| <b>3C</b>     | 100 | 31,29 |

### E-MegAlloy Oberplatten/Top Plates/plaquettes supérieures

|                 |    |      |
|-----------------|----|------|
| <b>140EMA</b>   | 25 | 2,08 |
| <b>190EMA</b>   | 25 | 2,17 |
| <b>1-1/2EMA</b> | 25 | 2,68 |
| <b>2EMA</b>     | 25 | 3,63 |

### C-MegAlloy

|                 |     |       |
|-----------------|-----|-------|
| <b>140CMA</b>   | 100 | 7,12  |
| <b>190CMA</b>   | 100 | 8,39  |
| <b>1-1/2CMA</b> | 100 | 9,93  |
| <b>2CMA</b>     | 100 | 13,74 |

### E-Rostfrei / Stainless / Inoxydable

|                |    |      |
|----------------|----|------|
| <b>140ES</b>   | 25 | 2,08 |
| <b>190ES</b>   | 25 | 2,17 |
| <b>1-1/2ES</b> | 25 | 2,68 |
| <b>2ES</b>     | 25 | 3,63 |

**Reparatur-Set** Eimer mit 50 Verbindern, HP1, HW1, 110  
und ca. 5 m LOK-Band

**Repair Set** Bucket containing 50 fasteners, HP1, HW1, 110  
and approx. 5 m LOK Tape

### E-Everdur

|                |    |      |
|----------------|----|------|
| <b>140EE</b>   | 25 | 2,08 |
| <b>190EE</b>   | 25 | 2,17 |
| <b>1-1/2EE</b> | 25 | 2,68 |
| <b>2EE</b>     | 25 | 3,63 |

**Jeu de réparation** Seau avec 50 agrafes, HP1, HW1, 110  
et env. 5 m de bande LOK

**FVS 140** 6,24  
**FVS 190** 6,51

### VP-Vulcanized Plate

| Bestell-Nr.<br>Order-No.<br>No. de réf. | Bandbreite<br>Belt Width<br>Largeur de bande<br>mm | Gewicht<br>Weight<br>Poids<br>kg |
|---|--|----------------------------------|
| <b>140VP</b>                            | 900 (5 X 180 mm)                                   | 2,48                             |
| <b>190VP</b>                            | 900 (5 X 180 mm)                                   | 2,62                             |
| <b>2VP</b>                              | 900 (5 X 180 mm)                                   | 3,58                             |

### Platten pro Verbindung Fasteners per Splice Plaquettes par jonction

| Bandbreite<br>Belt Width<br>Largeur de bande<br>mm | Grösse<br>Size<br>Taille |     | Grösse<br>Size<br>Taille |     | Grösse<br>Size<br>Taille |     |
|--|--------------------------|-----|--------------------------|-----|--------------------------|-----|
|  | 1, 140, 190<br>90°       | 45° | 1-1/2, 2, 2-1/4<br>90°   | 45° | 2-1/2, 3<br>90°          | 45° |
| 400  | 13                       | 19  | 10                       | 15  | 8                        | 12  |
| 500  | 16                       | 26  | 13                       | 21  | 10                       | 16  |
| 650  | 21                       | 33  | 17                       | 27  | 14                       | 21  |
| 800  | 26                       | 40  | 21                       | 32  | 17                       | 26  |
| 1000   | 32                       | 45  | 26                       | 36  | 21                       | 29  |
| 1200   | 39                       | 54  | 31                       | 43  | 26                       | 35  |
| 1400   | 46                       | 71  | 37                       | 51  | 30                       | 40  |

## Rißreparaturverbinder · Rip Repair Fasteners · Agrafes pour réparation de déchirure

| Bestell-Nr.<br>Order-No.<br>No. de réf. | Inhalt<br>Content<br>Contenu | Gewicht<br>Weight<br>Poids<br>kg | Bestell-Nr.<br>Order-No.<br>No. de réf.  | Inhalt<br>Content<br>Contenu | Gewicht<br>Weight<br>Poids<br>kg |
|---|------------------------------|----------------------------------|--|------------------------------|----------------------------------|
| <b>Stahl / Steel / Acier</b>            |                              |                                  | <b>Rostfrei / Stainless / Inoxydable</b> |                              |                                  |
| <b>RP1E</b>                             | 25                           | 2,14                             | <b>RP1ES</b>                             | 25                           | 2,24                             |
| <b>RP2E</b>                             | 25                           | 4,64                             | <b>RP2ES</b>                             | 25                           | 4,57                             |
| <b>16</b>                               | 50                           | 1,96                             |  |                              |                                  |

## FLEXCO Wedlock Verbindung\* · FLEXCO Wedlock Splice\* · FLEXCO Agrafes Wedlock\*

\*Weitere Informationen vgl. Broschüre FW/200 · More information in bulletin FW/200 · Plus d'information dans le bulletin FW/200

| Bestell-Nr.<br>Order-No.<br>No. de réf.   |  | Gewicht<br>Weight<br>Poids<br>kg |
|---|--|----------------------------------|
|  | <b>2W</b> Verbinderset – Splice Kit – Jeu d'agrafes  | 1,81                             |
|   | <b>2WS</b> Verbinderset rostfrei – Stainless Splice Kit – Jeu d'agrafes inoxydable           | 1,81                             |
|   | <b>2WL</b> Verbinderset Zugseite – Leading End Kit –<br>Jeu d'agrafes extrémité tirante      | 1,36                             |
|   | <b>2WT</b> Verbinderset gezogene Seite – Trailing End Kit –<br>Jeu d'agrafes extrémité tirée | 1,32                             |
|   | <b>T2W</b> Bohrschablonenset – Wedlock Templet Set – Jeu de gabarits                         | 2,86                             |

## SS Sechszackverbinder Stahl · Sixpoint Fasteners Steel · Agrafes à griffes acier

| Bestell-Nr.<br>Order-No.<br>No. de réf.  | Stück<br>Pieces<br>Pièces<br>mm | Bandstärke<br>Belt Thickness<br>Epais. de bande<br>mm | Spitzenlänge<br>Point Length<br>Longueur Pointes |
|--|---------------------------------|---|--|
|  | <b>SS200</b> 100                | 2,5 - 4   | 8  |
|  | <b>SS201</b> 100                | 4 - 6   | 10   |
|  | <b>SS202</b> 100                | 6 - 8   | 12   |
|  | <b>SS203</b> 100                | 8 - 10  | 15   |
|  | <b>SS204</b> 100                | 10 - 13   | 20   |
|  | <b>SS205</b> 100                | 13 - 15   | 23   |
|  | <b>SS206</b> 100                | 15 - 18   | 27   |
|  | <b>SS207</b> 100                | 18 - 21   | 35   |

## Bohrschablonen · Templets · Gabarits

| Bestell-Nr.<br>Order-No.<br>No. de réf. | Bestell-Nr.<br>Order-No.<br>No. de réf. | Bestell-Nr.<br>Order-No.<br>No. de réf. | Bandbreite<br>Belt Width<br>Largeur de bande<br>mm | Gewicht<br>Weight<br>Poids<br>kg |
|---|---|---|--|----------------------------------|
| <b>1-500</b>                            | <b>140-500</b>                          | <b>190-500</b>                          | 500  | 1,0                              |
| <b>1-650</b>                            | <b>140-650</b>                          | <b>190-650</b>                          | 650  | 1,3                              |
| <b>1-800</b>                            | <b>140-800</b>                          | <b>190-800</b>                          | 800  | 1,6                              |
| <b>1-1000</b>                           | <b>140-1000</b>                         | <b>190-1000</b>                         | 1000   | 2,0                              |
| <b>1-1200</b>                           | <b>140-1200</b>                         | <b>190-1200</b>                         | 1200   | 2,4                              |
| <b>1-1400</b>                           | <b>140-1400</b>                         | <b>190-1400</b>                         | 1400   | 2,8                              |
| <b>1-1/2-800</b>                        | <b>2-800</b>                            |   | 800  | 1,6                              |
| <b>1-1/2-1000</b>                       | <b>2-1000</b>                           |   | 1000   | 2,0                              |
| <b>1-1/2-1200</b>                       | <b>2-1200</b>                           |   | 1200   | 2,4                              |
| <b>1-1/2-1400</b>                       | <b>2-1400</b>                           |   | 1400   | 2,8                              |
| <b>2-1/4-800</b>                        | <b>2-1/2-800</b>                        | <b>3-800</b>                            | 800  | 1,6                              |
| <b>2-1/4-1000</b>                       | <b>2-1/2-1000</b>                       | <b>3-1000</b>                           | 1000   | 2,0                              |
| <b>2-1/4-1200</b>                       | <b>2-1/2-1200</b>                       | <b>3-1200</b>                           | 1200   | 2,4                              |
| <b>2-1/4-1400</b>                       | <b>2-1/2-1400</b>                       | <b>3-1400</b>                           | 1400   | 2,8                              |

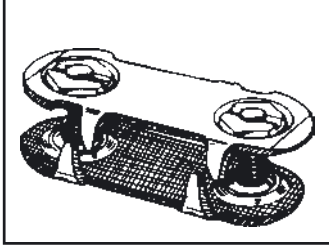

**Montagewerkzeuge  
für FLEXCO  
Bolt Solid Plate**

**Installation Tools  
for FLEXCO  
Bolt Solid Plate**

**Outillage de montage  
pour FLEXCO  
Bolt Solid Plate**

|   |   | Bestell-Nr.<br>Order-No.<br>No. de réf. | Verbindergröße<br>Fastener Size<br>Taille d'agrafe              | Gewicht<br>Weight<br>Poids<br>kg                                |  |
|---|---|---|---|---|--|
| <b>Manuelle Montage · Hand Tools · Montage manuel</b>       |   |   |   |   |  |
|   | Schraubenbrecher<br>Bolt Breaker<br>Casse-vis                                   | <b>110</b><br><b>112</b><br><b>113</b>  | 1, 140, 190, RP1, 375X, 550<br>1-1/2, 2, 2-1/4, RP2<br>2-1/2, 3 | 0,60<br>0,66<br>0,90  |  |
|   |   | Locheisen<br>Punch<br>Poinçon           | <b>P1P</b><br><b>P2P</b><br><b>P3P</b>                          | 1, 140, 190, RP1, 375X, 550<br>1-1/2, 2, 2-1/4, RP2<br>2-1/2, 3 | 0,06<br>0,10<br>0,13   |
|   |   |   | Steckschlüssel<br>Wrench<br>Clé à tube                          | <b>S1S</b><br><b>S2S</b><br><b>S3S</b>                          | 1, 140, 190, RP1, 375X, 550<br>1-1/2, 2, 2-1/4, RP2<br>2-1/2, 3      |
|   |   |   | Schraubenhorn<br>Bolthorn<br>Corne à vis                        | <b>2BH</b>  |  |
|   | Meißel<br>Cracking Chisel<br>Burin  |   | <b>C1C</b><br><b>C2C</b>  | 1, 140, 190, RP1, 375X, 550<br>1-1/2, 2, 2-1/4, RP2             | 0,54<br>0,54   |
|   | <b>Für Schlagschrauber · Power Tools · Outils pour boulonneuse à percussion</b> |   |   |   |  |
|   | Locheisen<br>Punch<br>Poinçon   | <b>HP1</b><br><b>HP2</b><br><b>HP3</b>  | 1, 140, 190, RP1, 375X, 550<br>1-1/2, 2, 2-1/4, RP2<br>2-1/2, 3 | 0,07<br>0,07<br>0,10  |  |
|   |   | Steckschlüssel<br>Wrench<br>Clé à tube  | <b>HW1</b><br><b>HW2</b><br><b>HW3</b>                          | 1, 140, 190, RP1, 375X, 550<br>1-1/2, 2, 2-1/4, RP2<br>2-1/2, 3 | 0,11<br>0,14<br>0,17   |
|   |   |   | Schnellkupplung<br>Quick Change Chuck<br>Mandrin serrage rapide | <b>5552</b>   | für HP + HW Werkzeuge<br>for HP + HW Tools<br>pour Outillage HP + HW |
| <b>FLEXCO-LOK Band · FLEXCO-LOK Tape · Bande FLEXCO-LOK</b> |   |   |   |   |  |
|   | Bestell-Nr.<br>Order-No.<br>No. de réf.   | für<br>for<br>pour                      | Länge<br>Length<br>Longueur<br>m                                | Gewicht<br>Weight<br>Poids<br>kg                                |  |
|   | <b>FL7C</b>   | 1, 140                                  | 30  | 0,36  |  |
| <b>FL11C</b>  | 190, 1-1/2, 2, 2-1/4, 2-1/2, 3  | 30                                      | 0,45  |   |  |
|   | Makita Schlagschrauber<br>Nr. 6905H   | Makita Impact Tool<br>Nr. 6905H         | Boulonneuse Makita<br>n° 6905H                                  |   |  |

## Extra Schrauben und Muttern

## Extra Bolts and Nuts

## Vis et écrous supplémentaires

### Extra Schrauben Extra Bolts Vis supplémentaires

#### Stahl / Steel / Acier

| Bestell-Nr.<br>Order-No.<br>No. de réf. | Verbindergröße<br>Fastener Size<br>Taille des agrafes | Gewicht<br>Weight<br>Poids<br>kg |
|---|---|----------------------------------|
| <b>20391</b>                            | 1   | 0,80                             |
| <b>20398</b>                            | RP1, 375X   | 1,10                             |
| <b>20399</b>                            | 140, 190, 550   | 1,00                             |
| <b>20402</b>                            | 1-1/2   | 1,50                             |
| <b>20406</b>                            | 2, RP2  | 1,80                             |
| <b>20410</b>                            | 2-1/4   | 2,20                             |
| <b>20414</b>                            | 2-1/2, 3  | 3,40                             |

#### Rostfrei / Stainless / Inoxydable

|              |                          |      |
|--------------|--------------------------|------|
| <b>20400</b> | 140, 190, 375X, 550, RP1 | 1,50 |
| <b>20407</b> | 1-1/2, 2, RP2            | 1,80 |
| <b>20411</b> | 2-1/4                    | 2,20 |

#### Everdur

|              |               |      |
|--------------|---------------|------|
| <b>20397</b> | 140, 190      | 0,84 |
| <b>20409</b> | 1-1/2, 2, RP2 | 1,68 |

### Locheisensatz / Belt Punch Set / Jeu de poinçons

| Bestell-Nr.<br>Order-No.<br>No. de réf.<br>(6 - 24 mm) | Gewicht<br>Weight<br>Poids<br>kg |
|--|----------------------------------|
| <b>LS-1/06-24</b>                                      | 1,36                             |

### Locheisen einzeln / Belt Punch Spares / Poinçon de rechange

| Bestell-Nr.<br>Order-No.<br>(No. de réf.) | Ø<br>mm | Gewicht<br>Weight<br>Poids<br>kg |
|---|---------|----------------------------------|
| <b>L-06</b>                               | 6       | 0,06                             |
| <b>L-08</b>                               | 8       | 0,06                             |
| <b>L-10</b>                               | 10      | 0,06                             |
| <b>L-12</b>                               | 12      | 0,12                             |
| <b>L-14</b>                               | 14      | 0,12                             |
| <b>L-16</b>                               | 16      | 0,12                             |
| <b>L-18</b>                               | 18      | 0,18                             |
| <b>L-20</b>                               | 20      | 0,18                             |
| <b>L-22</b>                               | 22      | 0,18                             |
| <b>L-24</b>                               | 24      | 0,18                             |

### Extra Muttern Extra Nuts Écrous supplémentaires

#### Stahl / Steel / Acier

| Bestell-Nr.<br>Order-No.<br>No. de réf. | Verbindergröße<br>Fastener Size<br>Taille des agrafes | Gewicht<br>Weight<br>Poids<br>kg |
|---|---|----------------------------------|
| <b>20377</b>                            | 1, 140, 190, RP1 + 375X, 550                          | 0,30                             |
| <b>20378</b>                            | 1-1/2, 2, 2-1/4, RP2                                  | 0,50                             |
| <b>20379</b>                            | 2-1/2, 3  | 1,00                             |

#### Rostfrei / Stainless / Inoxydable

|              |                              |      |
|--------------|------------------------------|------|
| <b>20381</b> | 1, 140, 190, RP1 + 375X, 550 | 0,30 |
| <b>20382</b> | 1-1/2, 2, 2-1/4, RP2         | 0,50 |

#### Everdur

|              |                         |      |
|--------------|-------------------------|------|
| <b>20387</b> | 1, 140, 190, RP1 + 375X | 0,30 |
| <b>20388</b> | 1-1/2, 2, 2-1/4, RP2    | 0,50 |



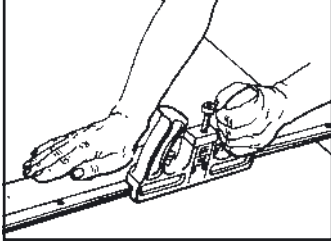

**ALLIGATOR/FLEXCO  
Bandschneider und  
Zubehör**

**ALLIGATOR/FLEXCO  
Belt Cutters and  
Accessories**

**ALLIGATOR/FLEXCO  
Coupeuses de bande  
et Accessoires**

|  | Bestell-Nr.<br>Order-No.<br>No. de réf. | Breite<br>Width<br>Largeur<br>mm | Gewicht<br>Weight<br>Poids<br>kg                                      |       |       |
|--|---|----------------------------------|---|-------|-------|
|  | Bandschneider                           | <b>300324</b>                    | 600   | 8,00  |       |
|  | Belt Cutter                             | <b>300330</b>                    | 750   | 8,70  |       |
|  | Coupeuse de bande                       | <b>300336</b>                    | 900   | 9,00  |       |
|  |   | <b>300342</b>                    | 1050  | 11,80 |       |
|  |   | <b>300348</b>                    | 1200  | 12,70 |       |
|  |   | <b>300360</b>                    | 1500  | 14,90 |       |
|  |   | <b>300372</b>                    | 1800  | 17,00 |       |
|  |   | <b>30023</b>                     | Klinge/Blade/Lame   |       | 0,10  |
|  |   | <b>300</b>                       | Griff/Handle/Manche   |       | 1,10  |
|  |   | <b>8D</b>                        | Nägel/Nails/Clous   |       | 0,50  |
|  | <b>845XXXLD</b>                         | <b>845836LD</b>                  | 900   | 12,00 |       |
|  | Bandschneider                           | <b>845848LD</b>                  | 1200  | 14,00 |       |
|  | Belt Cutter                             | <b>845860LD</b>                  | 1500  | 17,00 |       |
|  | Coupeuse de bande                       | <b>845872LD</b>                  | 1800  | 19,00 |       |
|  | -12 mm                                  | <b>840WA</b>                     | Griff/Handle/Manche   |       | 1,27  |
|  |   | <b>840SD</b>                     | Rechtw. Anschlagschiene<br>Squaring device<br>Rail fixe rectangulaire |       | 0,10  |
|  |   | <b>845-CBK</b>                   | Klinge/Blade/Lame   |       | 0,10  |
|  | <b>840XXX</b>                           | <b>840836</b>                    | 900   | 12,00 |       |
|  | Bandschneider                           | <b>840848</b>                    | 1200  | 14,00 |       |
|  | Belt Cutter                             | <b>840860</b>                    | 1500  | 17,00 |       |
|  | Coupeuse de bande                       | <b>840872</b>                    | 1800  | 19,00 |       |
|  | 10 - 20 mm                              | <b>840884</b>                    | 2100  | 22,00 |       |
|  |   | <b>840WA</b>                     | Griff/Handle/Manche   |       | 1,27  |
|  |   | <b>840SD</b>                     | Rechtw. Anschlagschiene<br>Squaring device<br>Rail fixe rectangulaire |       | 0,10  |
|  |   | <b>820/840-1CB</b>               | Klinge/Blade/Lame   |       | 0,10  |
|  | Elektro Bandschneider                   | <b>ITEC-170</b>                  | Schneider/Cutter/Coupeuse   |       | 14,30 |
|  | Electric Belt Cutter                    | <b>ITEC-170-BLADE</b>            | Klinge/Blade/Lame   |       | 1,00  |
|  | Coupeuse de bande                       | <b>ITEC-220</b>                  | Schneider/Cutter/Coupeuse   |       | 18,40 |
|  | électrique<br>(230 V / 50 Hz)           | <b>ITEC-220-BLADE</b>            | Klinge/Blade/Lame   |       | 1,50  |
|  | Elektro Raumaschine                     | <b>ITMBM</b>                     |   | 10,00 |       |
|  | Electric Buffing Machine                | <b>VW110-390</b>                 | Satz mit 4 Rauhscheiben<br>Set of 4 vain wheels<br>Jeu de 4 meuleuses |       | 1,60  |
|  | Machine électrique<br>à meuler          |                                  |   |       |       |





Bandhobel  
Belt Skiver  
Rabot pour bande

Bestell-Nr.  
Order-No.  
No. de réf.

EDV-Nr.  
Item-No.  
No. inf.

Gewicht  
Weight  
Poids  
kg

**FSK-1A**  
**FSK-1BA**

31995  
31996

Hobel/Skiver/Rabot  
verbesserte Klinge  
improved Blade  
Lame améliorée

9,30  
0,10

**FSK-1B**

31996

Klinge/Blade/Lame

0,10

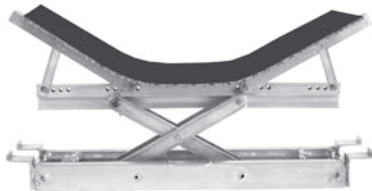

Gurtheber  
FLEX-Lifter  
Elévateur de bande

Bestell-Nr.  
Order-No.  
No. de réf.

für Bandbreite von  
for Belt Width of  
pour largeur de bande de  
mm

Gewicht  
Weight  
Poids  
kg

**FLEX-LIFTER M**  
**FLEX-LIFTER L**

900 - 1500  
1200 - 1800

39,00  
57,20



Akkuschrauber  
für Flex-Lifter  
**DeWalt DC920KB**

Cordless Drill  
for Flex-Lifter

**DeWalt DC920KB**

Visseuse sans fil  
pour Flex-Lifter

**DeWalt DC920KB**

Bandspannsysteme  
Far-Pull Belt Clamps  
Pinceur de bande

Bestell-Nr.  
Order-No.  
No. de réf.

Bandbreite  
Belt Width  
Largeur de bande  
mm

Gewicht  
Weight  
Poids  
kg

mit 4 Klemmbalken  
und 4 Klemmen  
with 4 clamp  
bars and 4 scissors  
avec 4 barres et  
4 pinces

**LSHD30/750**  
**LSHD36/900**  
**LSHD42/1050**  
**LSHD48/1200**  
**LSHD60/1500**  
**LSHD72/1800**

750  
900  
1050  
1200  
1500  
1800

29,50  
32,50  
35,00  
39,00  
44,00  
48,00

Klemmbalkenset (2 Stück)  
Belt Clamp Bar Set (2 Pieces)  
Jeu de barres (2 pièces)

**LSHDB30/750**  
**LSHDB36/900**  
**LSHDB42/1050**  
**LSHDB48/1200**  
**LSHDB60/1500**  
**LSHDB72/1800**

750  
900  
1050  
1200  
1500  
1800

9,00  
10,50  
12,00  
13,50  
16,50  
18,00

**LSHDS** Klemme / Scissors / Pinces

2,75

**ALLIGATOR/FLEXCO**  
Zubehör

**ALLIGATOR/FLEXCO**  
Accessories







**ALLIGATOR/FLEXCO**  
Accessoires

|   |  | Bestell-Nr.<br>Order-No.<br>No. de réf. | Gewicht<br>Weight<br>Poids<br>kg |
|---|--|---|----------------------------------|
|    | Kupplungsstabschneider<br>Hinge Pin Cutter<br>Pince à couper<br>les axes de jonction | <b>APC-1</b>                            | 0,23                             |
|    | Bandeckentrimmzange<br>Belt Nippers<br>Pince à rogner                                | <b>BN-1</b>                             | 0,36                             |
|    | Rillenhobel<br>Hand Skiver<br>Rabot pour courroie                                    | <b>RTBS-F</b>                           | 0,06                             |
|    | Bandschleifer<br>Belt Grinder<br>Meule pour bande                                    | <b>RB-1</b>                             | 0,34                             |
|  | Bandhalter (Paar)<br>Belt Grip (Pair)<br>Poignée pour bande (Jeux)                   | <b>22</b>                               | 1,13                             |
|  | Bandkebler<br>Belt Grover<br>Rabot pour bande  | <b>FBG1</b><br><b>HSP3</b>              | 0,82<br>0,02                     |
|  | Silikon Spray<br>Silicon Spray<br>Silicone   | <b>SL5-1</b>                            | 0,62                             |

**ROCKLINE**  
Förderbandzentrier-  
stationen und  
Seitenabdichtungen

**ROCKLINE**  
Conveyor Belt  
Positioner and Skirt  
Clamp

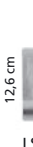



**ROCKLINE**  
Station de centrage pour  
bandes transporteuses et  
système latéral d'étanchéité

|   |   | Bestell-Nr.<br>Order-No.<br>No. de réf.                               | Bandbreite<br>Belt Width<br>Largeur de bande<br>mm    | Gewicht<br>Weight<br>Poids<br>kg |
|---|---|---|---|----------------------------------|
| <p>Förderbandzentrierstationen<br/>Conveyor Belt Positioner<br/>Station de centrage pour<br/>bandes transporteuses</p>    | mit Exalon Rollen<br>with Exalon Rollers<br>avec rouleaux exalone   | <b>RBP1E-S</b><br><b>RBP1E-M</b><br><b>RBP1E-L</b><br><b>RBP1E-XL</b> | 450 - 600<br>750 - 1200<br>1350 - 1800<br>1800 - 2400 | 27,40<br>33,30<br>42,60<br>82,50 |
|   | mit Stahl Rollen<br>with Steel Rollers<br>avec rouleaux en acier  | <b>RBP1S-S</b><br><b>RBP1S-M</b><br><b>RBP1S-L</b><br><b>RBP1S-XL</b> | 450 - 600<br>750 - 1200<br>1350 - 1800<br>1800 - 2400 | 31,70<br>38,30<br>49,60<br>90,50 |
|   | Standardausführung<br>Inhalt: 2 Antivibrationshaltestifte,<br>2 Klemmplatten, 1 Halteschiene 1,2 m lang   | <b>RMC1</b>   |   | 5,30                             |
|   | Standard length<br>Content: 2 Antivibration clamp pins,<br>2 clamp plates, 1 clamp bar 1,2 m long   |   |   |                                  |
|   | Version standard<br>Contenu: 2 clavettes antivibration, 2 cales,<br>1 barre de calage de longueur 1,2 m   |   |   |                                  |
|   | Sonderausführung<br>mit kurzen Klemmplatten (LS)<br>Inhalt: 2 Antivibrationshaltestifte, 2 Klemm-<br>platten (kurz), 1 Halteschiene 1,2 m lang  | <b>RMC1-LS</b>  |   | 4,70                             |
| Limited Space Edition (LS)<br>Content: 2 Antivibration clamp pins, 2 limited<br>space clamp plates, 1 clamp bar 1,2 m long  |   |   |   |                                  |
| Version spéciale avec cales courtes<br>Contenu: 2 clavettes antivibration, 2 cales<br>courtes, 1 barre de calage de longueur 1,2 m  |   |   |   |                                  |
|  <p>PAL PAK</p>  <p>12,6 cm<br/>LS</p>  <p>17,8 cm<br/>Standard</p> |   | <b>PAL PAK</b><br><b>LS PAL PAK</b>                                   |   | 3,00<br>2,50                     |
|   |  <p>Bolt-On PAL PAK</p>  <p>12,6 cm<br/>LS</p>  <p>17,8 cm<br/>Standard</p> |   | <b>Bolt-On PAL PAK</b><br><b>Bolt-On LS PAL PAK</b>   |                                  |
| Bestell-Nr.<br>Order-No.<br>No. de réf.   |   |   |   | Gewicht<br>Weight<br>Poids<br>kg |
| <b>RMC1-CP</b>  | Haltestift / Clamp Pin / Clavette   |   |   | 0,50                             |
| <b>RMC1-BCP</b>   | Haltestift zum Schrauben / Bolt-on Clamp Pin / Goupille à visser  |   |   | 0,45                             |
| <b>RMC1-PL</b>  | Klemmplatte / Clamp Plate / Cale  |   |   | 0,95                             |
| <b>RMC1LS-PL</b>  | Klemmplatte kurz / Limited Space Clamp Plate / Cale courte  |   |   | 0,68                             |
| <b>RMC1-CB</b>  | Halteschiene / Clamp Bar / Barre de calage  |   |   | 1,81                             |

**ROCKLINE/  
ELIMINATOR**  
Bandreinigungssysteme

**ROCKLINE/  
ELIMINATOR**  
Diagonal Plow/  
Precleaner

**ROCKLINE/  
ELIMINATOR**  
Chasse-pierres diagonal/  
Pré-racleur

|  |                             | Bestell-Nr.<br>Order-No.<br>No. de réf. | Bandbreite<br>Belt Width<br>Largeur de bande<br>mm | Gewicht<br>Weight<br>Poids<br>kg                 |                                  |
|--|-----------------------------|---|--|--|----------------------------------|
|   | <b>ROCKLINE</b>             | <b>RDP1-S</b>                           | 450 - 750  | 20,40  |                                  |
|  | Diagonal Pflugabstreifer    | <b>RDP1-M</b>                           | 900 - 1050   | 25,40  |                                  |
|  | Diagonal Plow               | <b>RDP1-L</b>                           | 1200 - 1500  | 31,70  |                                  |
|  | Chasse-pierres diagonal     | <b>RDP1-XL</b>                          | 1800 - 2100  | 43,50  |                                  |
|  | Ersatzblätter               | <b>RDPBK-S</b>                          | 450 - 750  | 1,80   |                                  |
|  | Replacement Blade Kits      | <b>RDPBK-M</b>                          | 900 - 1050   | 2,50   |                                  |
|  | Kit de remplacement de lame | <b>RDPBK-L</b>                          | 1200 - 1500  | 3,80   |                                  |
|  |                             | <b>RDPBK-XL</b>                         | 1800 - 2100  | 5,50   |                                  |
| <p><b>Hinweis:</b> Verwenden Sie den grösseren Abstreifer bei Zwischenbandbreiten<br/> <b>Notice:</b> Use next larger size for belt widths between ranges<br/> <b>Remarque:</b> Pour des largeurs de bandes intermédiaires, utilisez le modèle supérieur</p> |                             |   |  |  |                                  |
|    | <b>ELIMINATOR</b>           | <b>CBV-XS</b>                           | 450 - 600  | 24,00  |                                  |
|  | V-Pflugabstreifer           | <b>CBV-S</b>                            | 750 - 900  | 29,45  |                                  |
|  | V-Plow                      | <b>CBV-M</b>                            | 1050 - 1200  | 33,50  |                                  |
|  | Chasse-pierres en V         | <b>CBV-L</b>                            | 1350 - 1500  | 38,05  |                                  |
|  | Ersatzblätter               | <b>VBK-XS</b>                           |  | 2,05   |                                  |
|  | Replacement Blade Kits      | <b>VBK-S</b>                            |  | 2,70   |                                  |
|  | Kit de remplacement de lame | <b>VBK-M</b>                            |  | 3,40   |                                  |
|  |                             | <b>VBK-L</b>                            |  | 4,10   |                                  |
|  | Ersatzblätter aus Urethan   | <b>VUBK-XS</b>                          |  | 2,45   |                                  |
|  | Urethane Blade Kits         | <b>VUBK-S</b>                           |  | 3,65   |                                  |
| Kit de remplacement de lame en uréthane  | <b>VUBK-M</b>               |   | 4,75   |  |                                  |
|  | <b>VUBK-L</b>               |   | 5,90   |  |                                  |
| <p><b>Hinweis:</b> Verwenden Sie den grösseren Abstreifer bei Zwischenbandbreiten<br/> <b>Notice:</b> Use next larger size for belt widths between ranges<br/> <b>Remarque:</b> Pour des largeurs de bandes intermédiaires, utilisez le modèle supérieur</p> |                             |   |  |  |                                  |
|   |                             | Bestell-Nr.<br>Order-No.<br>No. de réf. | Bandbreite<br>Belt Width<br>Largeur de bande<br>mm | Blattbreite<br>Blade Width<br>Largeur Lame<br>mm | Gewicht<br>Weight<br>Poids<br>kg |
|  | <b>ROCKLINE</b>             | <b>EZP1-824</b>                         | 500  | 400  | 25,90                            |
|  | Kopfabstreifer mit ConShear | <b>EZP1-830</b>                         | 650  | 550  | 28,60                            |
|  | Blätter                     | <b>EZP1-836</b>                         | 800  | 700  | 31,25                            |
|  | Precleaner with ConShear    | <b>EZP1-842</b>                         | 1000   | 850  | 34,00                            |
|  | Blades                      | <b>EZP1-848</b>                         | 1200   | 1000   | 36,60                            |
|  | Pré-racleur avec lames      | <b>EZP1-854</b>                         | 1350   | 1150   | 39,30                            |
|  | ConShear                    | <b>EZP1-860</b>                         | 1400   | 1300   | 42,00                            |
|  |                             | <b>EZP1-866</b>                         | 1600   | 1450   | 43,20                            |
|  |                             | <b>EZP1-872</b>                         | 1800   | 1600   | 44,60                            |
|   | <b>MINELINE</b>             | <b>MSP-824</b>                          | 500  | 400  | 36,50                            |
|  | Kopfabstreifer mit ConShear | <b>MSP-830</b>                          | 650  | 500  | 39,40                            |
|  | Blätter                     | <b>MSP-836</b>                          | 800  | 700  | 43,30                            |
|  | Precleaner with ConShear    | <b>MSP-842</b>                          | 1000   | 850  | 46,80                            |
|  | Blades                      | <b>MSP-848</b>                          | 1200   | 1000   | 50,10                            |
|  | Pré-racleur avec lames      | <b>MSP-854</b>                          | 1350   | 1150   | 53,10                            |
|  | ConShear                    | <b>MSP-860</b>                          | 1400   | 1300   | 55,80                            |
|  |                             | <b>MSP-866</b>                          | 1600   | 1450   | 59,80                            |
|  | <b>MSP-872</b>              | 1800                                    | 1600   | 61,00  |                                  |

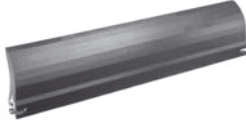
|   |                            | Bestell-Nr.<br>Order-No.<br>No. de réf. | für Modell<br>for Cleaner<br>pour racleur | Blattbreite<br>Blade Width<br>Largeur lame<br>mm | Gewicht<br>Weight<br>Poids<br>kg |
|---|----------------------------|---|---|--|----------------------------------|
|  | <b>ROCKLINE / MINELINE</b> | <b>CRB16</b>                            | EZP1-824/MSP-824                          | 405  | 3,30                             |
|   | ConShear Ersatzblätter     | <b>CRB22</b>                            | EZP1-830/MSP-830                          | 550  | 4,60                             |
|   | ConShear Spare Blades      | <b>CRB28</b>                            | EZP1-836/MSP-836                          | 710  | 5,80                             |
|   | Lames de remplacement      | <b>CRB34</b>                            | EZP1-842/MSP-842                          | 860  | 7,00                             |
|   | ConShear                   | <b>CRB40</b>                            | EZP1-848/MSP-848                          | 1015   | 8,30                             |
|   |                            | <b>CRB46</b>                            | EZP1-854/MSP-854                          | 1170   | 9,50                             |
|   |                            | <b>CRB52</b>                            | EZP1-860/MSP-860                          | 1320   | 10,80                            |
|   |                            | <b>CRB58</b>                            | EZP1-866/MSP-866                          | 1475   | 12,00                            |
|   |                            | <b>CRB64</b>                            | EZP1-872/MSP-872                          | 1625   | 13,30                            |

|  | <b>MINELINE</b>                         |  | <b>Cartridge Kits for Competition Cleaners</b>  |  | <b>Kit d'installation pour autres racleurs en service</b> |  |
|---|---|--|---|--|---|--|
|   | Bestell-Nr.<br>Order-No.<br>No. de réf. | Bandbreite<br>Belt Width<br>Largeur de bande | SSRB Blätter<br>SSRB Blades<br>Lames SSRB<br>mm | Gesamtbreite<br>Total Width<br>Largeur total<br>mm | Gewicht<br>Weight<br>Poids<br>kg                          |  |
|   | <b>MHCP-BCK24</b>                       | 500 - 600                                    | 3   | 450  | 15,00   |  |
|   | <b>MHCP-BCK30</b>                       | 650 - 750                                    | 4   | 600  | 20,00   |  |
|   | <b>MHCP-BCK36</b>                       | 800 - 900                                    | 5   | 750  | 25,00   |  |
|   | <b>MHCP-BCK42</b>                       | 1000 - 1050                                  | 6   | 900  | 30,00   |  |
|   | <b>MHCP-BCK48</b>                       | 1100 - 1200                                  | 7   | 1050   | 35,00   |  |
|   | <b>MHCP-BCK54</b>                       | 1300 - 1350                                  | 8   | 1200   | 40,00   |  |
|   | <b>MHCP-BCK60</b>                       | 1400 - 1500                                  | 9   | 1350   | 45,00   |  |
|   | <b>MHCP-BCK72</b>                       | 1600 - 1800                                  | 10  | 1500   | 55,00   |  |

**SSRB** SuperShear Blatt / SuperShear Blade / Lame SuperShear 2,95

|  | <b>ROCKLINE</b>                                      |  | <b>EZS – Sekundärabstreifer</b>               |                            | <b>EZS – Secondary Belt Cleaners</b> |  | <b>EZS – Racleurs secondaires</b> |  |  |
|--|--|--|---|----------------------------|--------------------------------------|--|-----------------------------------|--|--|
|  | Bestellnummer<br>Order-No.<br>No. de réf.            | Bandbreite<br>Belt Width<br>Largeur de bande | Blattbreite<br>Blade Width<br>Largeur de lame | Klingen<br>Blades<br>Lames | Gewicht<br>Weight<br>Poids<br>kg     |  |                                   |  |  |
|  | <b>EZS2-18</b>                                       | 500  | 450   | 3                          | 32,20                                |  |                                   |  |  |
|  | <b>EZS2-24</b>                                       | 650  | 600   | 4                          | 34,40                                |  |                                   |  |  |
|  | <b>EZS2-30</b>                                       | 800  | 750   | 5                          | 36,10                                |  |                                   |  |  |
|  | <b>EZS2-36</b>                                       | 1000   | 900   | 6                          | 38,70                                |  |                                   |  |  |
|  | <b>EZS2-42</b>                                       | 1200   | 1050  | 7                          | 40,50                                |  |                                   |  |  |
|  | <b>EZS2-48</b>                                       | 1400   | 1200  | 8                          | 42,70                                |  |                                   |  |  |
|  | <b>EZS2-54</b>                                       | 1400   | 1350  | 9                          | 44,90                                |  |                                   |  |  |
|  | <b>EZS2-60</b>                                       | 1600   | 1500  | 10                         | 61,80                                |  |                                   |  |  |
|  | Ersatzklingen – Replacement Tips – Lames de rechange |  |   |                            |                                      |  |                                   |  |  |
|  | <b>EZS2TK</b>  |  | 150   |                            | 0,41                                 |  |                                   |  |  |

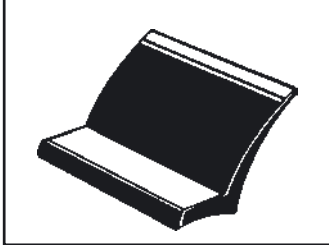

## TATCH A CLEAT



Schraubstollen und  
Führungsprofile

Mechanical Belt  
Cleats and Guides

Profils à vis et de  
guidage

|                | <b>Hinweis:</b><br>Weitere Informationen<br>finden Sie in unserer<br>Broschüre TAC 100. | <b>Notice:</b><br>For further Information see<br>our Brochure TAC 100. | <b>Renvoi:</b><br>Pour d'autres informations<br>veuillez consulter notre<br>brochure TAC 100.  |  |  |   |
|----------------|---|--|--|--|--|---|
| Tatch-A-Cleat  | Zusammensetzung<br>Compound<br>Composition  | Min. Trommel-Ø<br>Min. Pulley-Ø<br>Ø tambour mini<br>mm                | Temperatur-<br>einsatzbereich<br>Temperature<br>Service Range<br>Température<br>Rayon d'action | Abriebbeständigkeit<br>Abrasion Resistance<br>Résistance<br>à l'abrasion | Ölbeständigkeit<br>Oil Resistance<br>Résistance<br>à l'huile | Säurebeständigkeit<br>Acid Resistance<br>Résistance aux<br>acides |
| <b>L</b>       | Weiß/Schwarz Nitril - FDA<br>White/Black Nitril - FDA<br>blanc/noir nitril - FDA        | 50   | -40°<br>bis / up to / jusqu'à<br>+ 110° C  | +  | ++   | +   |
| <b>EC</b>      | Schwarz EPDM<br>Black EPDM<br>noir EPDM   | EC1-3: 75<br>EC4: 100<br>EC6: 150                                      | -55°<br>bis / up to / jusqu'à<br>+ 150° C  | ++   | N/A  | ++  |
| <b>HD</b>      | Schwarz SBR<br>Black SBR<br>noir SBR  | 75   | -40°<br>bis / up to / jusqu'à<br>+ 80° C   | ++   | N/A  | 0   |
| <b>LUG/PEG</b> | Tan Isopren FDA<br>Tan Isoprene FDA<br>tan isoprène FDA                                 | 80   | -40°<br>bis / up to / jusqu'à<br>+ 80° C   | ++   | N/A  | +   |
| <b>GUIDE</b>   | Schwarz Neopren<br>Black Neoprene<br>noir neoprène                                      | A: 100<br>B: 150<br>C: 200   | -40°<br>bis / up to / jusqu'à<br>+ 110° C  | +  | +  | +   |

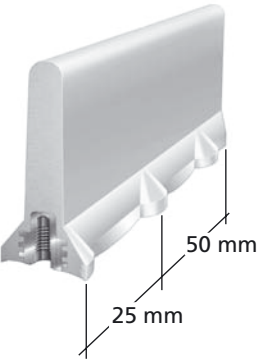
| <b>HD</b> Profile<br>Cleats<br>Profils   |   | Bestell-Nr.<br>Order-No.<br>No. de Réf. | Höhe<br>Height<br>Hauteur<br>mm | Inhalt<br>Content<br>Contenu | Gewicht<br>Weight<br>Poids<br>kg |
|--|---|---|---------------------------------|------------------------------|----------------------------------|
|  | Schwarz, verzinkte Schrauben<br>Black, plated Fasteners<br>Noir, vis galvanisées    | <b>HD-1</b>                             | 25                              | 10X610 mm                    | 5,22                             |
|  |   | <b>HD-2</b>                             | 50                              | 5X610 mm                     | 4,30                             |
|  | Schwarz, rostfreie Schrauben<br>Black, stainless Fasteners<br>Noir, vis inoxydables | <b>HD-1S</b>                            | 25                              | 10X610 mm                    | 5,35                             |
|  |   | <b>HD-2S</b>                            | 50                              | 5X610 mm                     | 4,30                             |
| <b>Extra Schrauben und<br/>Unterlegscheiben<br/>Extra Bolts and Washers<br/>Vis et rondelles<br/>supplémentaires</b> | verzinkt, plated, galvanisées   | <b>HD1-F</b>                            | 25                              | 123                          | 1,24                             |
|  |   | <b>HD1-1/4-F</b>                        | 32,5                            | 123                          | 1,50                             |
|  | rostfrei, stainless, inoxydables  | <b>HD1-FS</b>                           | 25                              | 123                          | 1,24                             |
|  |   | <b>HD2-1/4-FS</b>                       | 32,5                            | 123                          | 1,50                             |
| <b>EC</b> Profile<br>Cleats<br>Profils   | Schwarz, verzinkte Schrauben<br>Black, plated Fasteners<br>Noir, vis galvanisées    | <b>EC1-1/4</b>                          | 32                              | 5X1220 mm                    | 5,67                             |
|  |   | <b>EC2</b>                              | 51                              |                              | 7,03                             |
|  |   | <b>EC3</b>                              | 76                              |                              | 9,98                             |
|  |   | <b>EC4</b>                              | 102                             |                              | 14,97                            |
|  |   | <b>EC6</b>                              | 152                             | 2X1220 mm                    | 12,84                            |
|  |   |   |                                 |                              |                                  |
| <b>Extra Schrauben<br/>Extra Bolts<br/>Vis supplémentaires</b>   | verzinkt, plated, galvanisées   | <b>ECF</b>                              |                                 | 61                           | 1,27                             |
|  |   | <b>EC4F</b>                             |                                 | 61                           | 1,50                             |
|  |   | <b>EC6F</b>                             |                                 | 33                           | 0,91                             |
|  | rostfrei, stainless, inoxydables  | <b>ECFS</b>                             |                                 | 61                           | 1,32                             |

|   |  | Bestell-Nr.<br>Order-No.<br>No. de réf.   | Höhe<br>Height<br>Hauteur<br>mm   | Inhalt<br>Content<br>Contenu  | Gewicht<br>Weight<br>Poids<br>kg                                       |  |                          |                              |
|---|--|---|---|---|--|--|--------------------------|------------------------------|
|  <p><b>Profile Cleats Profils</b></p> | Schwarz, verzinkte Schrauben<br>Black, plated Fasteners<br>Noir, vis galvanisées   | <b>L5/8-B</b><br><b>L1-B</b><br><b>L1-1/2-B</b><br><b>L2-B</b><br><b>L3-B</b>   | 16<br>25<br>38<br>54<br>76  | 10X610 mm   | 3,31<br>4,22<br>5,08<br>6,35<br>8,31                                   |  |                          |                              |
|   | Schwarz, rostfreie Schrauben<br>Black, stainless Fasteners<br>Noir, vis inoxydables  | <b>L5/8-BS</b><br><b>L1-BS</b><br><b>L1-1/2-BS</b><br><b>L2-BS</b><br><b>L3-BS</b>  | 16<br>25<br>38<br>54<br>76  | 10X610 mm   | 3,31<br>4,22<br>5,08<br>6,35<br>8,31                                   |  |                          |                              |
|   | Weiß, verzinkte Schrauben<br>White, plated Fasteners<br>Blanc, vis galvanisées   | <b>L5/8-W</b><br><b>L1-W</b><br><b>L1-1/2-W</b><br><b>L2-W</b><br><b>L3-W</b>   | 16<br>25<br>38<br>54<br>76  | 10X610 mm   | 3,31<br>4,22<br>5,58<br>6,58<br>8,75                                   |  |                          |                              |
|   | Weiß, rostfreie Schrauben<br>White, stainless Fasteners<br>Blanc, vis inoxydables  | <b>L5/8-WS</b><br><b>L1-WS</b><br><b>L1-1/2-WS</b><br><b>L2-WS</b><br><b>L3-WS</b>  | 16<br>25<br>38<br>54<br>76  | 10X610 mm   | 3,31<br>4,22<br>5,58<br>6,58<br>8,75                                   |  |                          |                              |
|   | <b>Extra Schrauben und Unterlegscheiben</b><br>für L/LUG/PEG<br><b>Extra Bolts and Washers</b><br>for L/LUG/PEG<br><b>Vis et rondelles supplémentaires</b><br>pour L/LUG/PEG | Bandstärkenbereich<br>Belt Thickness Range<br>Épaisseur de bande<br>L1/2-F/FS -8 mm<br>L5/8-F/FS 7-11 mm<br>L3/4-F/FS >11 mm    | verzinkt / plated / galvanisées<br><b>L1/2-F</b><br><b>L5/8-F</b><br><b>L3/4-F</b>        | 12<br>16<br>19  | 123<br>123<br>123  | 0,45<br>0,45<br>0,59                     |                          |                              |
|   |  |   | rostfrei / stainless / inoxydables<br><b>L1/2-FS</b><br><b>L5/8-FS</b><br><b>L3/4-FS</b>  | 12<br>16<br>19  | 123<br>123<br>123  | 0,45<br>0,45<br>0,59                     |                          |                              |
|   |  <p><b>LUG Profile Cleats Profils</b></p> <p><b>PEG Profile Cleats Profils</b></p>         |   | <b>LG1-1/2-C</b><br><b>LG-2-C</b><br><b>PG2</b><br><b>PG3</b>                             | 38<br>51<br>51<br>76  | 100<br>100<br>100<br>100   | 3,00<br>3,21<br>1,95<br>3,13             |                          |                              |
|   |  |  <p><b>GUIDE Profile / Cleats Profils</b></p> | Schwarz, verzinkte Schrauben<br>Black, plated Fasteners<br>Noir, vis galvanisées          | <b>A10</b><br><b>B10</b><br><b>C10</b>  | 10X200 mm  | 13X10<br>16X12<br>26X16                  | 0,45<br>0,59<br>1,49     |                              |
|   |  |   | Schwarz, rostfreie Schrauben<br>Black, stainless Fasteners<br>Noir, vis inoxydables       | <b>A10S</b><br><b>B10S</b><br><b>C10S</b>   | 10X200 mm  | 13X10<br>16X12<br>26X16                  | 0,45<br>0,59<br>1,49     |                              |
|   |  |   | <b>Extra Unterlegscheiben</b><br><b>Extra Washers</b><br><b>Rondelles supplémentaires</b> | verzinkt, plated, galvanisées<br>Rostfrei / Stainless / Inoxydable<br>verzinkt, plated, galvanisées | <b>CW1024</b><br><b>CWS1024</b><br><b>CW25/100</b><br><b>CWS25/100</b> | L/LUG/PEG<br>L/LUG/PEG<br>HD/EC<br>HD/EC | 100<br>100<br>100<br>100 | 0,20<br>0,20<br>0,40<br>0,40 |
|   |  |   |   |   |  |  |                          |                              |
|   |  |   |   |   |  |  |                          |                              |

ANKER-FLEXCO GmbH  
Leidringer Straße 40 - 42  
D-72348 Rosenfeld

Telefon +49-74 28 - 94 06-0  
Telefax +49-74 28 - 94 06-260  
e-mail: [info@anker-flexco.de](mailto:info@anker-flexco.de)  
Internet: [www.anker-flexco.de](http://www.anker-flexco.de)

**ANKER  
FLEXCO**

TRANSPORTBAND-VERBINDUNGSSYSTEME  
CONVEYOR BELT FASTENING SYSTEMS  
SYSTÈMES D'AGRAFAGE POUR BANDES TRANSPORTEUSES